



METĀLKALUMI

ORNAMENTAL STEEL

www.deksteel.lv



www.lni.lv

lni
mācību centrs

- Darba drošība un aizsardzība
- Metināšanas procesu un procedūru sertifikācija
- Konsultācijas darba drošības jautājumos



**Drošs
būs
vēl
drošāks**

67509441

Lāčplēša ielā 106/108, Rīga
e-pasts: lni@lni.lv



You can become
our distributor!

ORNAMENTAL STEEL

Head ofiss
Sia "Ornamental steel"
Ofiss: Radiostacijas iela 21d,
Ulbroka, Latvija
Mob.: +371 20360910



UAB "VIDALSTA"
Address: Kęstučio street 1A,
Lentvaris, LT-25124 Trakai district
Mob: +370 61087440
Email: darius@vidalsta.lt
WEB: www.vidalsta.lt

You can become
our distributor!

You can become
our distributor!

■ Jaunumi



□	12x6	12x12
HxL (mm)	360x120	Ø 120
Nº	10.400	11.333



□	855x800	80x525	645x645
Nº	13.400	13.401	13.402



□	14x14	14x14	1000	1000	12x12	14x14	16x16
HxL (mm)	950x200	950	1000	1000	200	200	200
Nº	20.101	22.004.01	23.100	23.101	40.400	40.400.01	40.400.02

ORNAMENTAL STEEL



<input type="checkbox"/>		
HxL (mm)	192x55	180x60
Nº	41.411	42.412



<input type="checkbox"/>	
HxL (mm)	1360x810
Nº	65.005

<input type="checkbox"/>	
HxL (mm)	230x430
Nº	65.300



■ velmējumi no plakandzelža 12 x 6 mm

■ scrolls made of a flat bar 12 x 6 mm

■ спиральные элементы из полос 12 x 6 мм

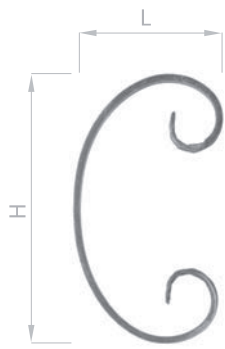

	H	L	N°
12x6	80	50	10.091
12x6	95	60	10.092
12x6	150	75	10.097
12x6	160	80	10.098
12x6	220	120	10.099



	H	L	N°
12x6	80	50	10.200
12x6	100	60	10.201
12x6	120	70	10.202
12x6	130	75	10.203
12x6	160	80	10.204
12x6	220	130	10.205

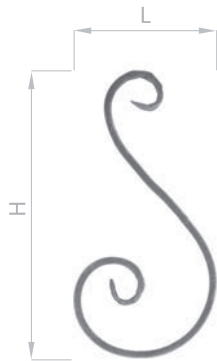

	H	L	N°
12x6	150	70	10.100
12x6	230	115	10.101
12x6	260	115	10.102
12x6	195	90	10.104
12x6	300	120	10.107
12x6	330	130	10.108

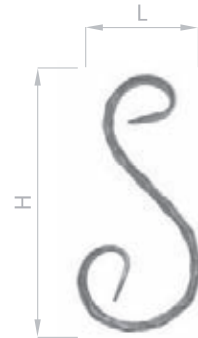

	H	L	N°
12x6	150	65	10.206
12x6	170	80	10.207
12x6	220	100	10.208
12x6	270	110	10.209
12x6	300	120	10.210
12x6	330	130	10.211



	H	L	N°
A 12x6	250	75	10.125



	H	L	N°
A 12x6	460	80	10.130



	H	L	N°
12x6	120	80	10.109

ORNAMENTAL STEEL

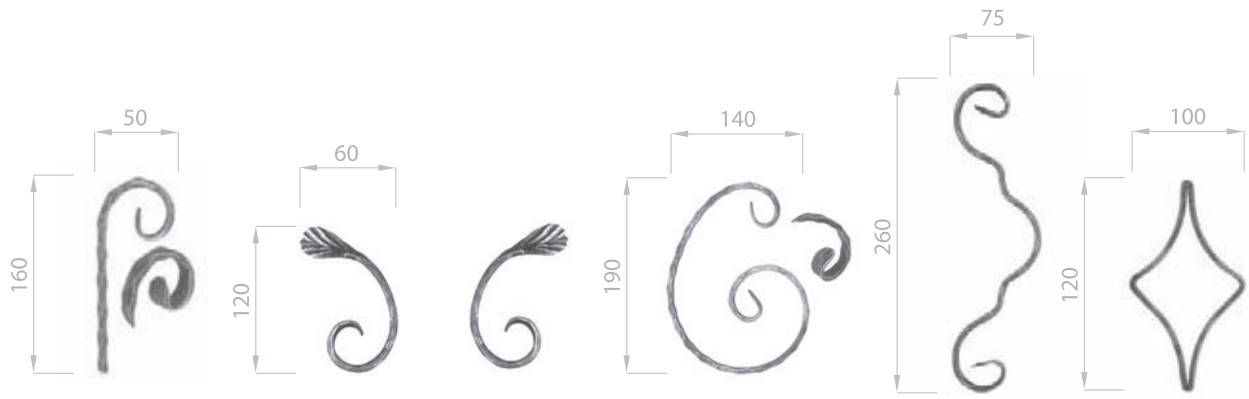

□	12x6	12x6	12x6	12x6	12x6	12x6
HxL (mm)	160x50	120x60	120x60	190x140	260x75	120x100
N°	10.213	10.215	10.216	10.217	10.221	10.224

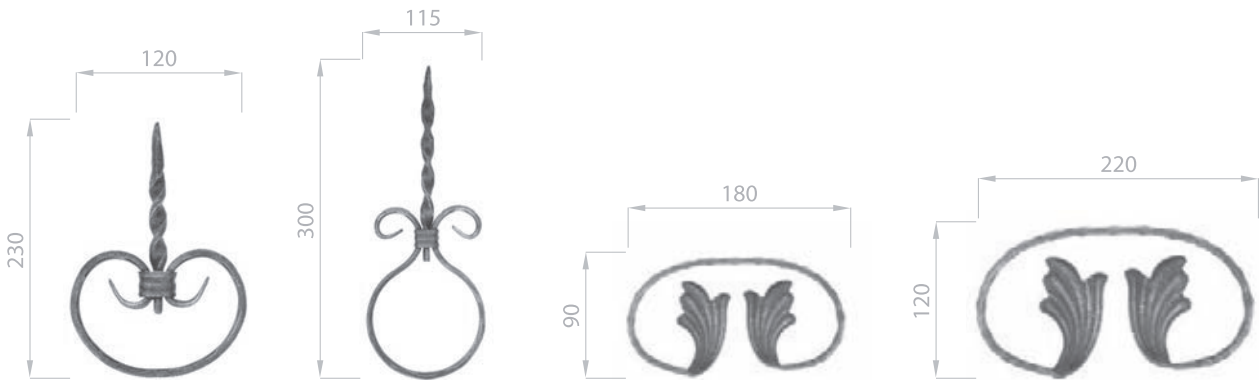

□	12x6	12x6	12x6	12x6
HxL (mm)	230x120	300x115	180x90	220x120
N°	10.226	10.227	10.230	10.231



□	12x6	12x6	12x6	12x6	12x6	12x6
HxL (mm)	150x100	150x100	190x140	190x140	150x100	150x100
N°	10.240	10.241	10.242	10.243	10.250	10.251

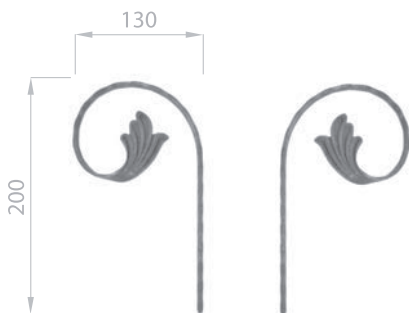

□	12x6	12x6
HxL (mm)	200x130	200x130
N°	10.252	10.253

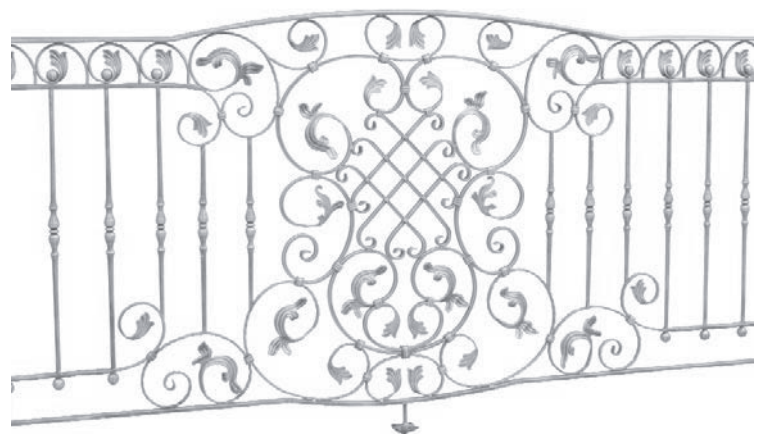

■ velmējumi no plakandzelža 12 x 12 mm

■ scrolls made of a bar 12 x 12 mm

■ спиральные элементы из прутьев 12 x 12 мм

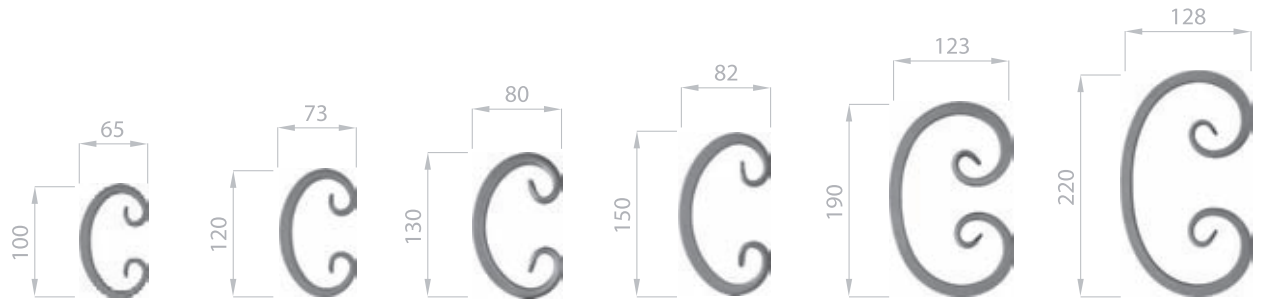

□	12x12	12x12	12x12	12x12	12x12	12x12
HxL (mm)	100x65	120x73	130x80	150x82	190x123	220x128
Nº	10.300	10.301	10.302	10.303	10.304	10.305

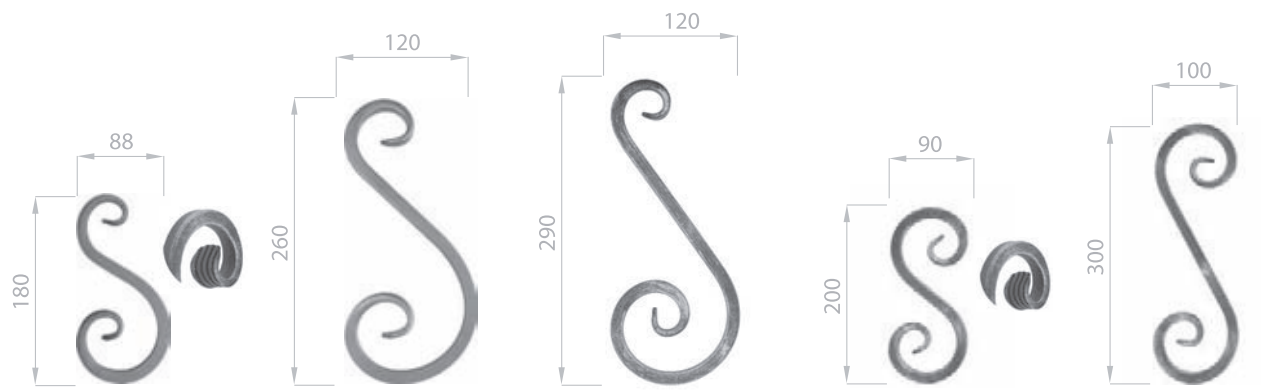

□	12x12	12x12	12x12	12x12	12x12
HxL (mm)	180x88	260x120	290x120	200x90	300x100
Nº	10.310	10.312	10.313	10.315	10.316

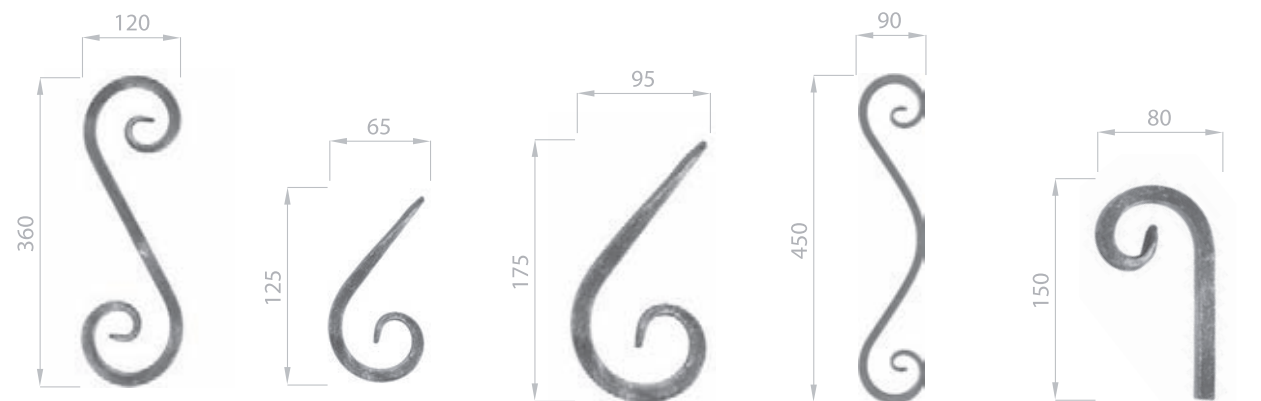

□	12x12	12x12	12x12	12x12	12x12
HxL (mm)	360x120	125x65	175x95	450x90	150x80
Nº	10.317	10.320	10.322	10.330	10.340

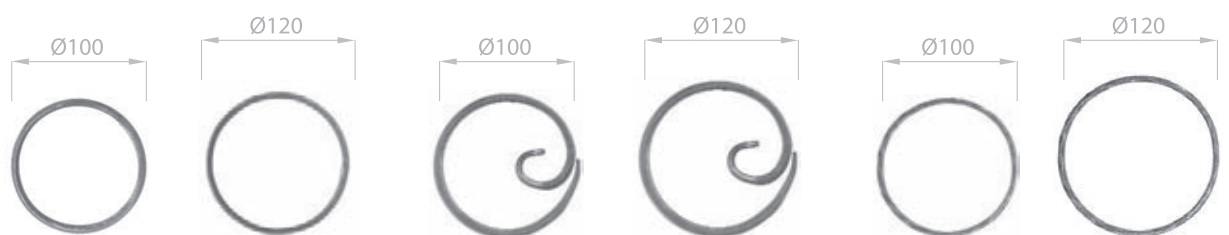

□	12x6	12x6	12x6	12x6	12x6	12x6
HxL (mm)	Ø100	Ø120	Ø100	Ø120	Ø100	Ø120
Nº	11.031	11.032	11.041	11.042	11.231	11.232

ORNAMENTAL STEEL



□	12x6	12x6	12x12	12x12	12x12
HxL (mm)	Ø100	Ø120	Ø100	Ø120	Ø160
N°	11.241	11.242	11.331	11.332	11.333

■ Vērpsti čiekuri ■ baskets ■ корзины

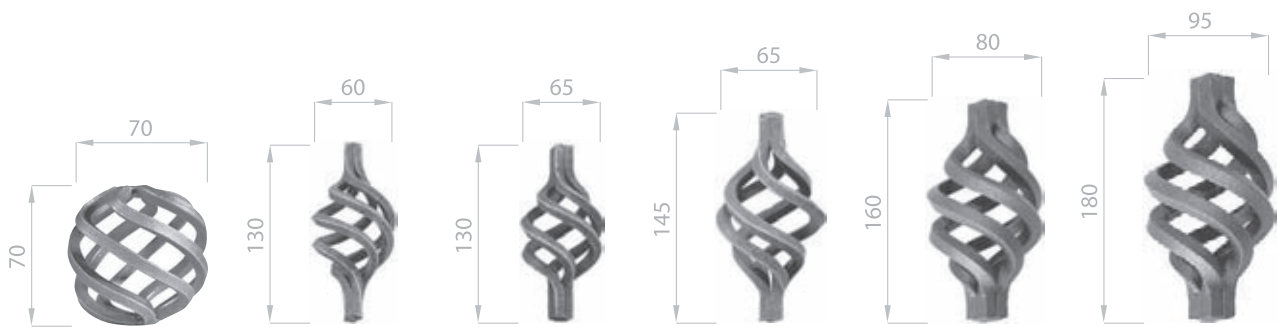

□	6x6	12x12	14x14	16x16	20x20	24x24
HxL (mm)	70x70	130x60	130x65	145x65	160x80	180x95
N°	12.010	12.080	12.081	12.082	12.083	12.084

■ rozet ■ rosettes ■ розетки



□	12x12	12x6
HxL (mm)	130x65	240x240
N°	12.111	13.000

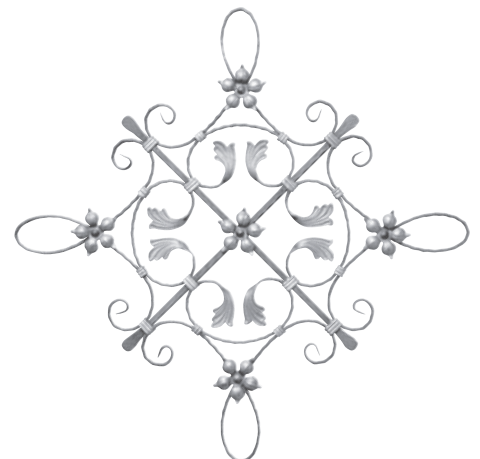
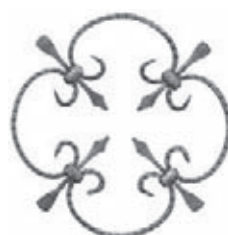

□	20x4	12x12/12x6	10x5	12x6
HxL (mm)	250x250	375x300	250x250	640x640
N°	13.005	13.006	13.007	13.010

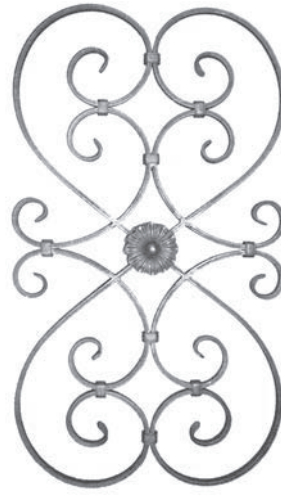
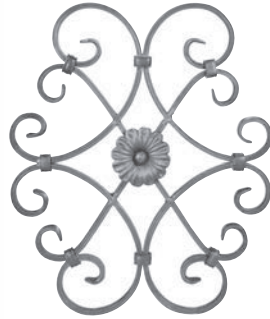

□	16x8	16x8	16x8	12x12
HxL (mm)	710x640	480x410	800x440	530x420
N°	13.012	13.016	13.017	13.018

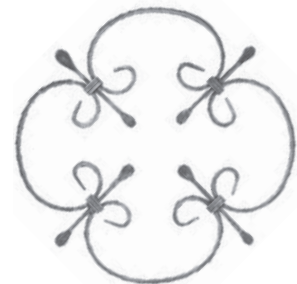

□	12x6
HxL (mm)	400x400
N°	13.021



□	12x12	16x8	16x8
HxL (mm)	590x590	590x510	800x800
N°	13.025	13.026	13.028

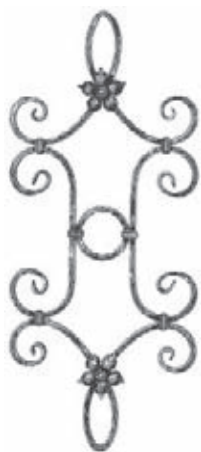

□	12x12	12x12
HxL (mm)	900x385	560x400
Nº	13.030	13.032



□	12x12	12x12	12x12	12x12
HxL (mm)	600x370	510x690	480x320	450x340
Nº	13.033	13.034	13.035	13.037



□	12x12	16x8	16x8	16x8
HxL (mm)	500x250	370x880	800x275	800x275
Nº	13.038	13.042	13.043	13.044



□	16x8
HxL (mm)	800x180
N°	13.059



□	12x6
HxL (mm)	230x740
N°	13.067



□	16x8
HxL (mm)	220x1200
N°	13.069



□	16x8
HxL (mm)	380x1500
N°	13.071

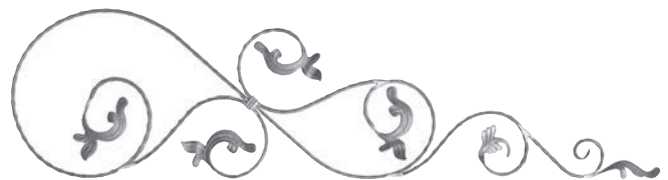

□	16x8
HxL (mm)	380x1500
N°	13.072

ORNAMENTAL STEEL

□	16x8
HxL (mm)	170x970
Nº	13.090



□	16x8
HxL (mm)	135x950
Nº	13.091

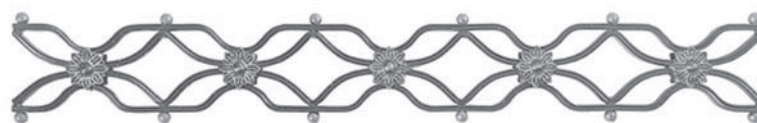

□	Ø12
HxL (mm)	170x970
Nº	13.092

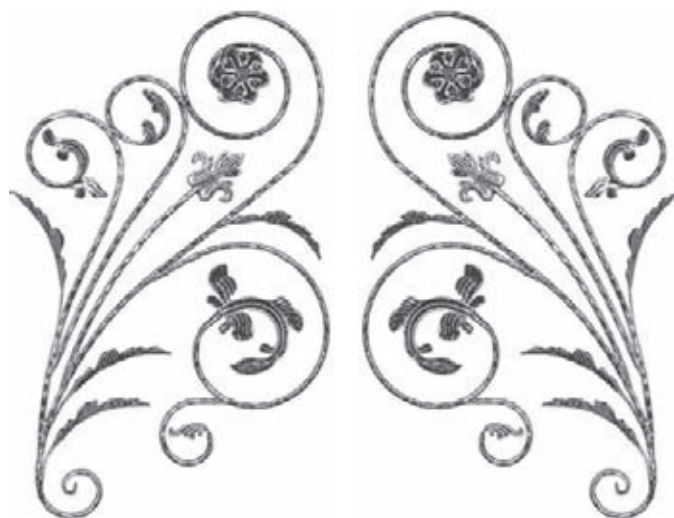
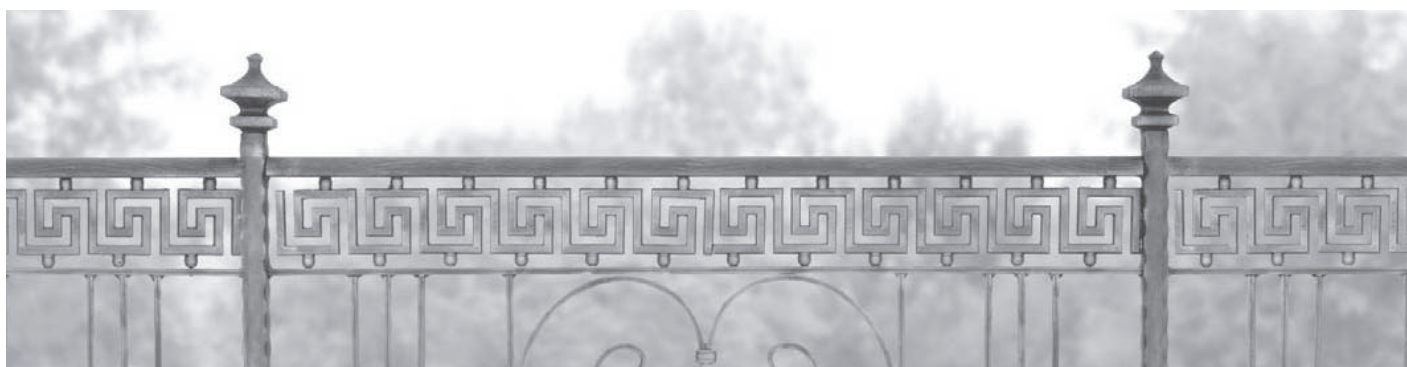

□	Ø12	Ø12
HxL (mm)	1080x600	1080x600
Nº	13.100	13.101

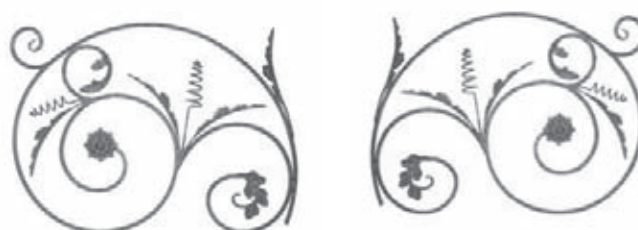

□	Ø12	Ø12
HxL (mm)	550x750	550x750
Nº	13.102	13.103

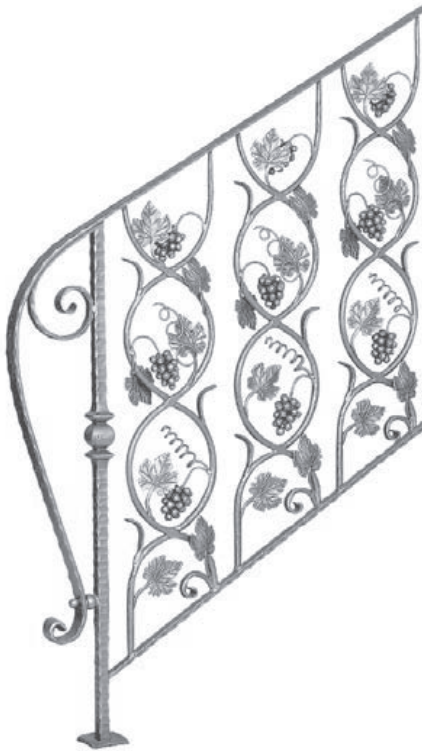

□	Ø14	Ø14
HxL (mm)	800x165	1000x215
Nº	13.202	13.203



□	12x12
HxL (mm)	800x680
Nº	13.230



□	Ø12	Ø12	Ø12	Ø12
HxL (mm)	950x880	950x880	300x190	300x190
Nº	13.209	13.210	50.175	50.176

ORNAMENTAL STEEL

■ izliekti statņi ■ shaped balusters ■ фасонные балясины

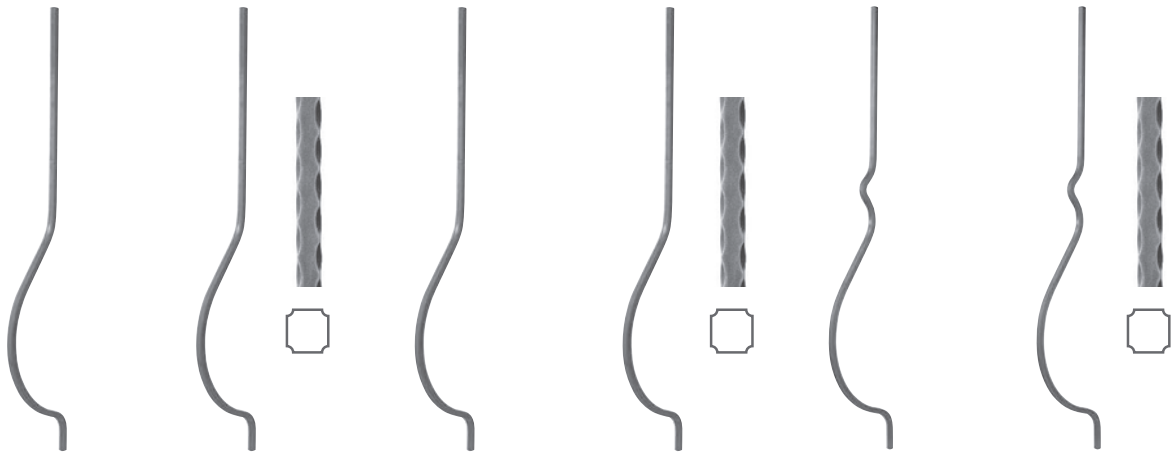

□	12x12	12x12	14x14	14x14	12x12	12x12
HxL (mm)	950x165	950x165	950x165	950x165	950x165	950x165
N°	20.001	20.001.01	20.002	20.002.01	20.003	20.003.01

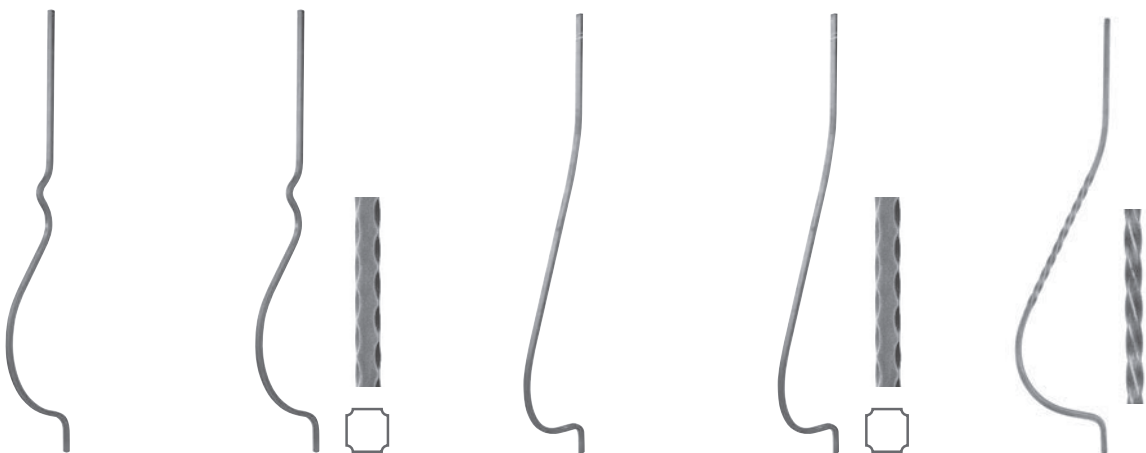

□	14x14	14x14	12x12	12x12	12x12
HxL (mm)	950x165	950x165	950x200	950x200	950x200
N°	20.004	20.004.01	20.010	20.010.01	20.011

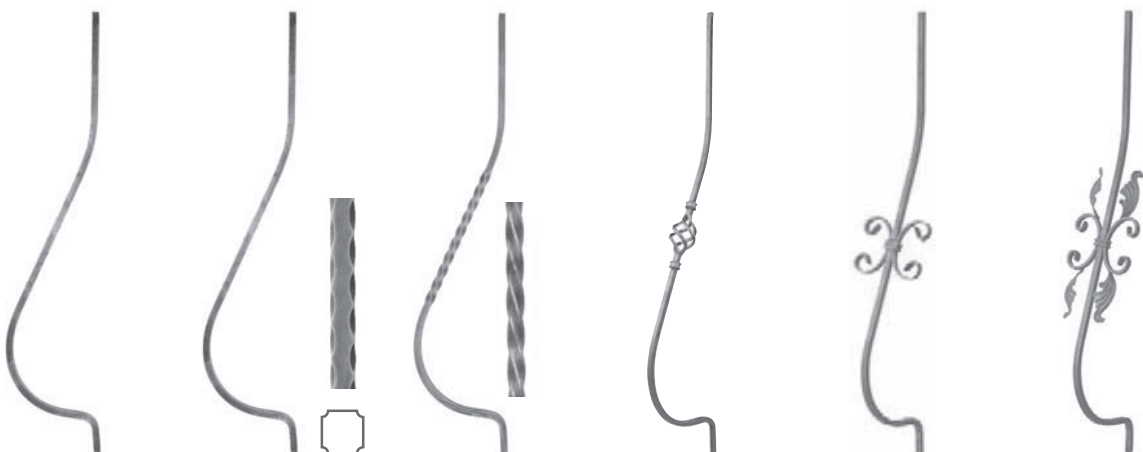

□	14x14	14x14	14x14	12x12	12x12/12x6	12x12
HxL (mm)	950x200	950x200	950x200	950x200	950x200	950x200
N°	20.012	20.012.01	20.013	20.020	20.030	20.031



□	12x12/12x6	12x12/12x6	12x12	14x14	14x14	16x16
HxL (mm)	950x200	950x200	950x200	950x200	950x110	950x225
N°	20.040	20.041	20.100	20.101	20.110	20.149

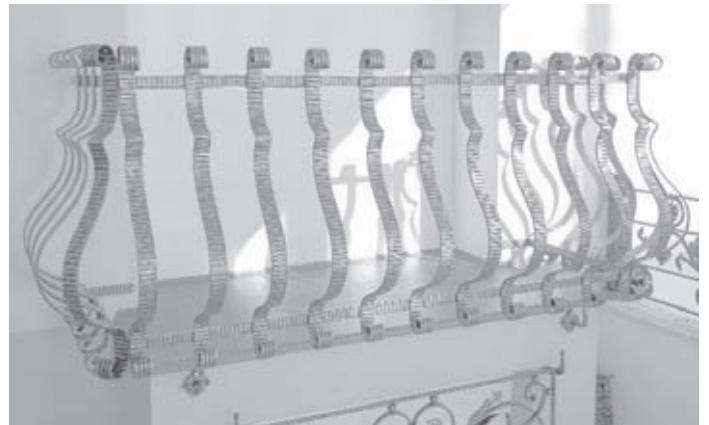

■ taisni stieņi ■ plain balusters ■ гладкие балясины

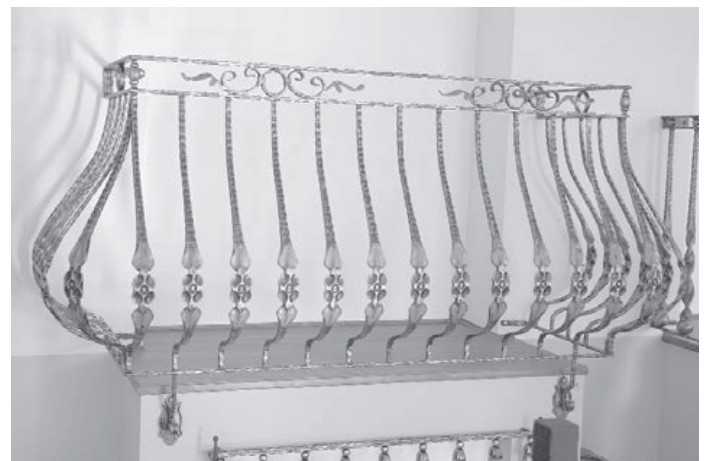

□	12x12	12x12	12x12
HxL (mm)	950	950	950
N°	21.010	21.011	21.022

ORNAMENTAL STEEL



□	12x12	12x12	12x12	12x12/12x6	12x12/12x6	12x12/12x6	12x12/12x6
HxL (mm)	950	950	950	950x155	950x155	950x155	950x170
N°	21.023	21.024	21.025	21.026	21.027	21.028	21.029

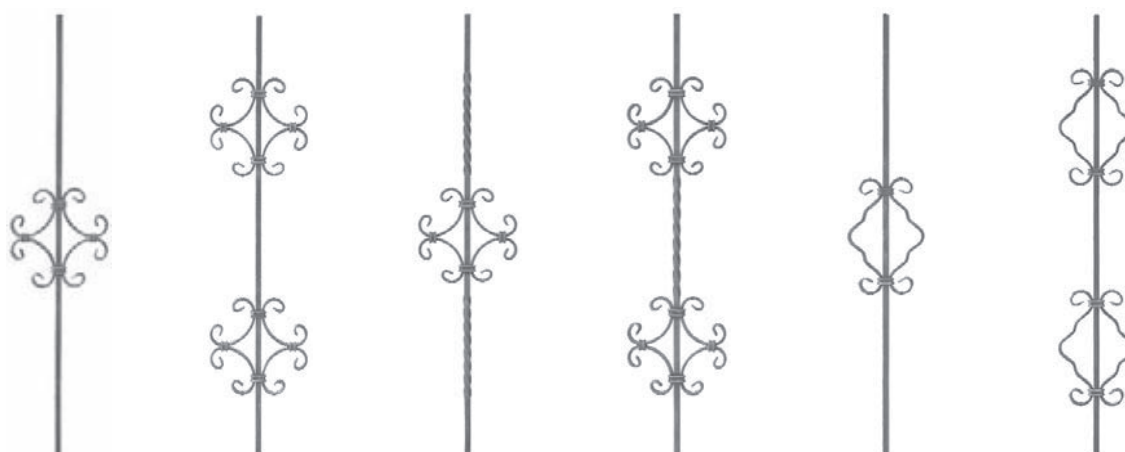

□	12x12/12x6	12x12/12x6	12x12/12x6	12x12/12x6	12x12/12x6	12x12/12x6
HxL (mm)	950x210	950x210	950x210	950x210	950x165	950x165
N°	21.030	21.031	21.032	21.033	21.034	21.035

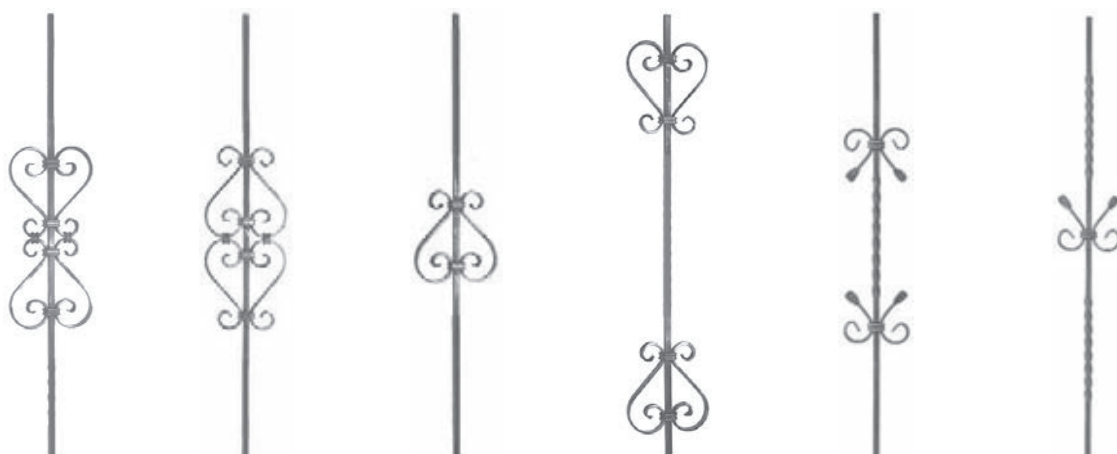

□	12x12/12x6	12x12/12x6	12x12/12x6	12x12/12x6	12x12/12x6	12x12/12x6
HxL (mm)	950x155	950x155	950x155	950x155	950x150	950x150
N°	21.036	21.037	21.038	21.039	21.040	21.041



□	12x12/12x6	12x12/12x6	12x12/12x6	12x12/12x6	12x12/12x6	12x12/12x6
HxL (mm)	950x210	950x210	950x170	950x170	950x170	950x170
Nº	21.042	21.043	21.044	21.045	21.046	21.047

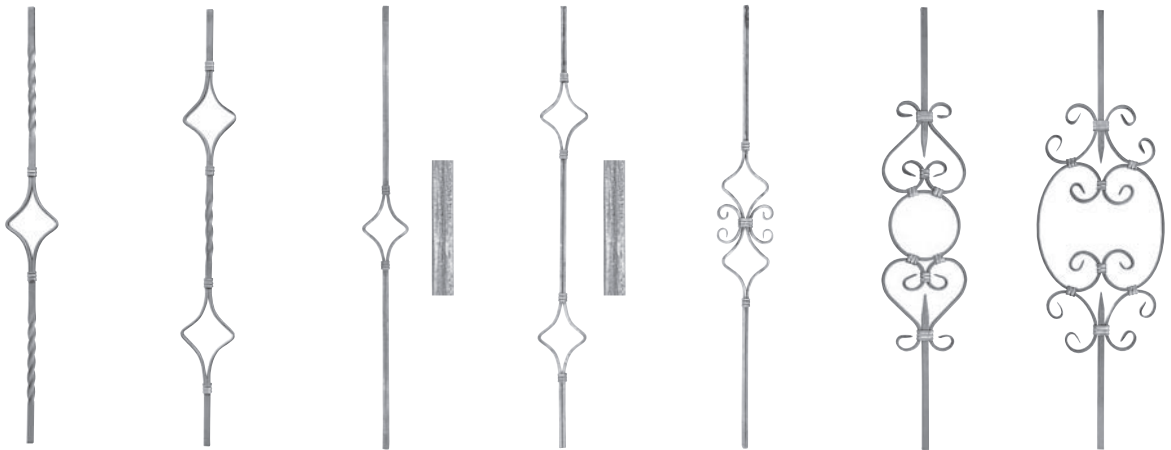

□	12x12/12x6	12x12/12x6	12x12/12x6	12x12/12x6	12x12/12x6	12x12/12x6	12x12/12x6
HxL (mm)	950x110	950x110	950x95	950x95	950x115	950x170	950x235
Nº	21.048	21.049	21.050	21.051	21.052	21.053	21.054

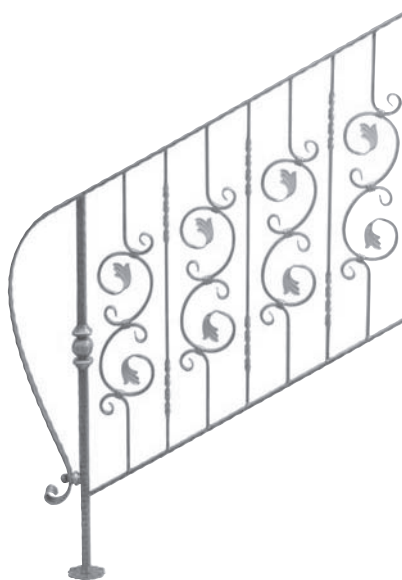

ORNAMENTAL STEEL



□	12x12	12x12/12x6	12x12/12x6	12x12/12x6	12x12/12x6	12x12/12x6
HxL (mm)	950x100	950x155	950x155	950x155	950x155	950x230
Nº	21.061	21.111	21.112	21.113	21.114	21.115



□	12x6
HxL (mm)	860x350
Nº	21.116

■ statņi ar tekstūru ■ textured balusters ■ фактурные балясины



□	12x12/12x6	16x8	Ø14	Ø14	12x12	12x12	14x14	12x12	12x12
HxL (mm)	950x95	950x155	950	950	950	950	950	950	950
Nº	21.117	21.118	22.001	22.002	22.003	22.004	22.004.01	22.007	22.008



□	12x12	12x12	12x12	12x12	12x12	12x12	12x12	12x12
HxL (mm)	950x170	950x155	950x170	950x155	950	950	1000x60	950x140
N°	22.009	22.010	22.011	22.012	22.019	22.020	22.055	22.100

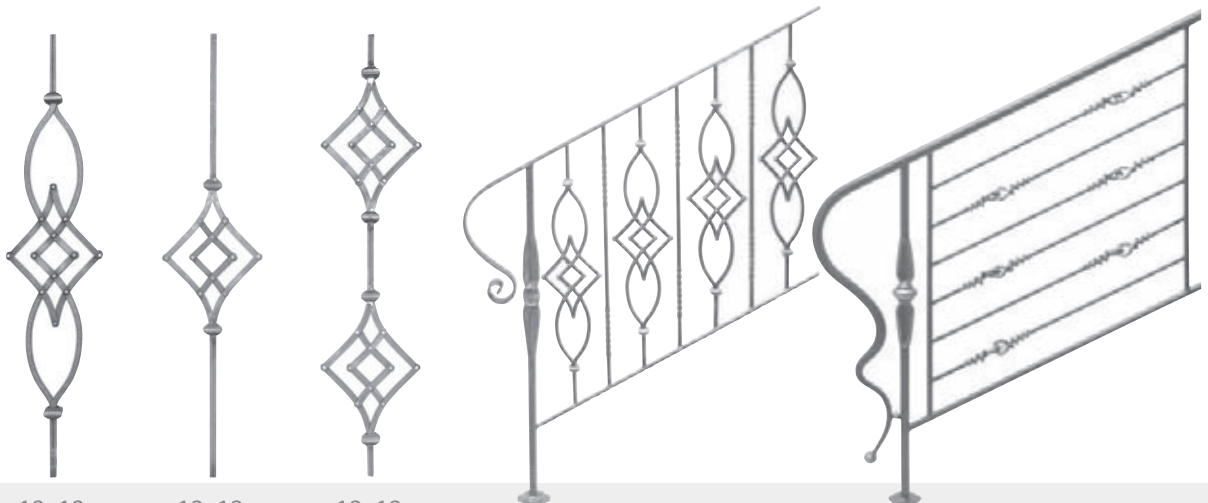

□	12x12	12x12	12x12
HxL (mm)	950x185	950x180	950x180
N°	22.103	22.104	22.105

■ presēti statņi ■ forged balusters ■ кованные балясины



□	Ø12	Ø12	14x14	14x14		
H (mm)	950	950	950	950	1000	1000
N°	23.001	23.002	23.003	23.004	23.100	23.101

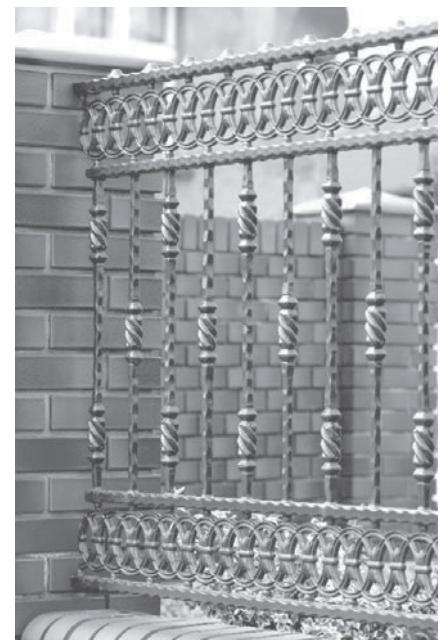

ORNAMENTAL STEEL

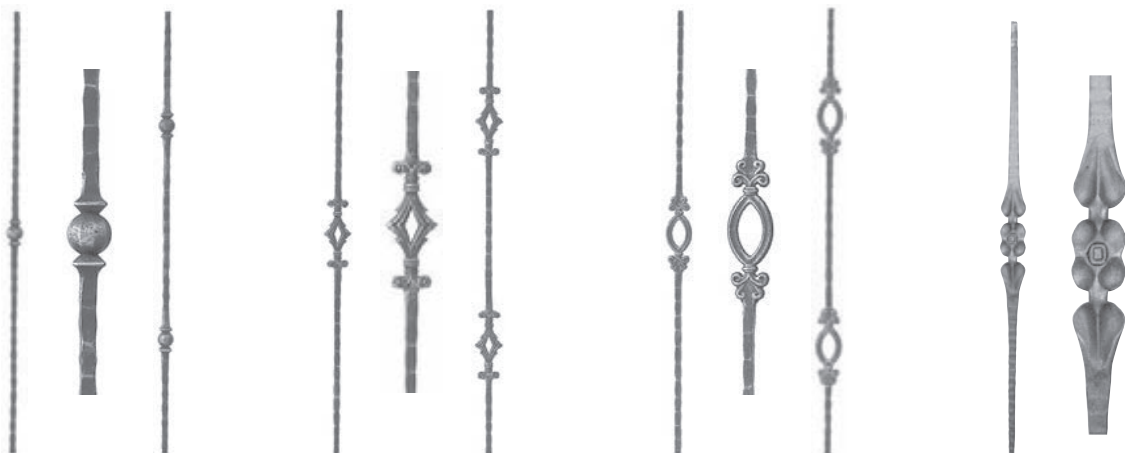

□	14x14	14x14	14x14	14x14	14x14	14x14	16x16
H (mm)	950	950	950	950	950	950	950x40
N°	23.009	23.010	23.011	23.012	23.013	23.014	23.061

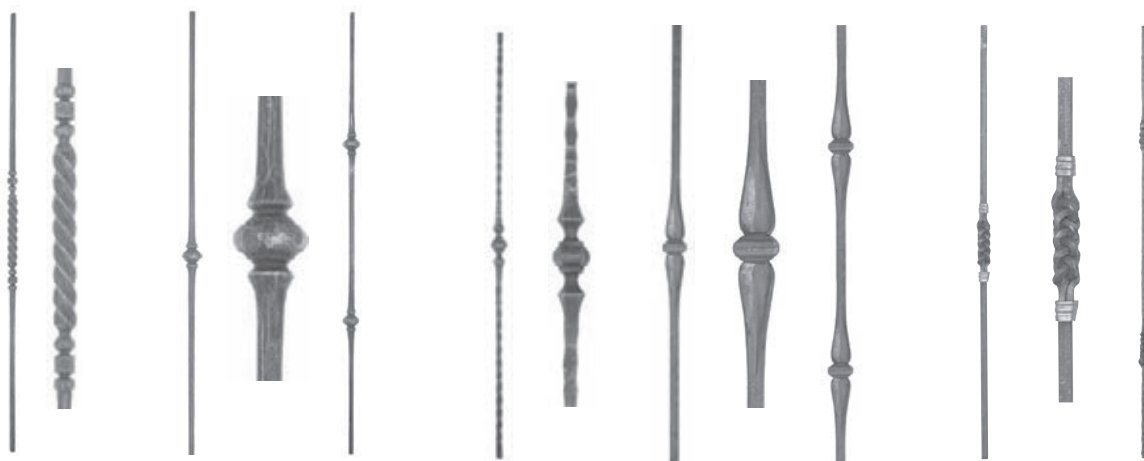

□	Ø12	Ø12	Ø12	14x14	14x14	14x14	12x12	12x12
H (mm)	950	950	950	950	950	950	950	950
N°	23.019	23.020	23.021	23.024	23.025	23.026	23.028	23.029

■ balsta statņi ■ baluster posts ■ балюстрадные столбы



□	20x20	25x25	25x25	25x25	Ø28	25x25	25x25	25x25	25x25
H (mm)	1200	1200	1200	1200	1200	1200	1200	1200	1200
N°	24.011	24.023	24.101	24.106	24.112	24.151	24.254	24.257	24.259

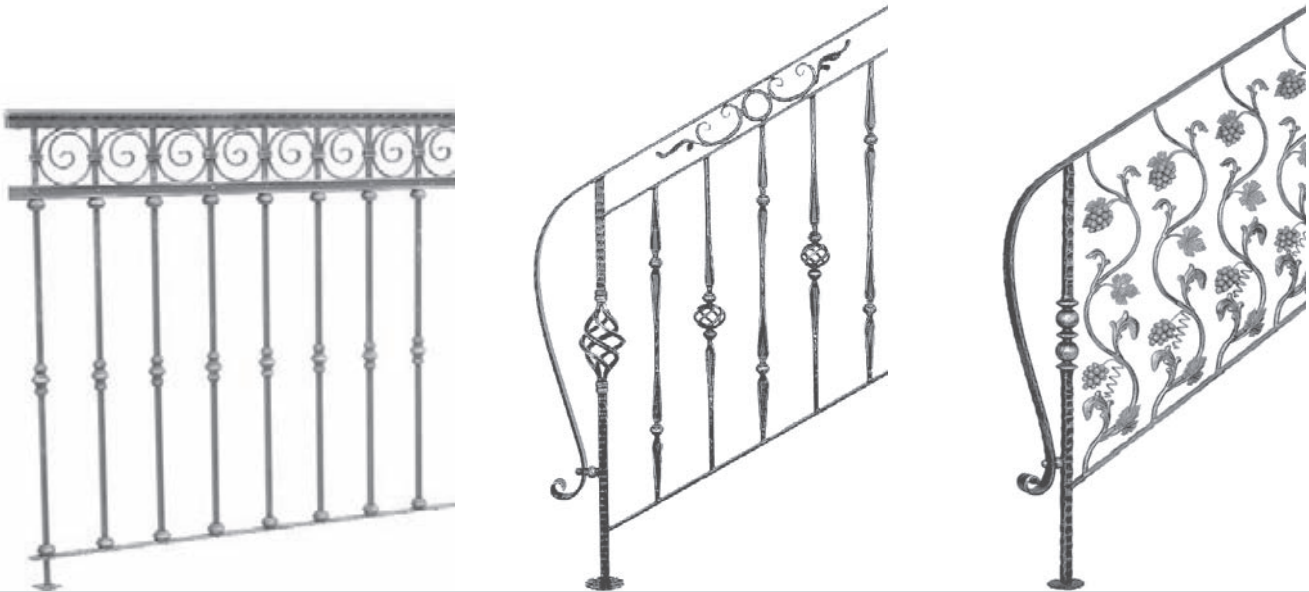

■ velmētas sloksnes ■ flat bars, railings ■ полосы, поручни

profil



□	40x12	40x12	40x12	40x12
HxL (mm)	3000	680	180x300	400
N°	30.001	30.001.02	30.001.03	30.001.04



profil



□	50x14	50x14	50x14	50x14
HxL (mm)	3000	680	180x300	400
N°	30.002	30.002.02	30.002.03	30.002.04



ORNAMENTAL STEEL



□	48x20	48x20	48x20	62x30	62x30	62x30
HxL (mm)	3000x1,5	3000x1,5	3000x1,5	3000x1,5	3000x1,5	3000x1,5
N°	30.020	30.020.01	30.020.02	30.021	30.021.01	30.021.02



□	54x54	54x54	54x54	48x20	62x30	54x54
HxL (mm)	3000x1,5	3000x1,5	3000x1,5	40	50	36
N°	30.022	30.022.01	30.022.02	30.030	30.031	30.032

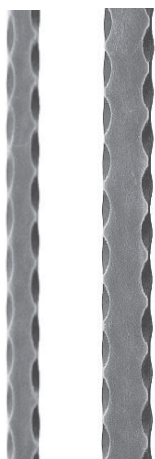

□	H	N°
20x5	3000	30.100
25x5	3000	30.101
30x5	3000	30.102
40x5	3000	30.105

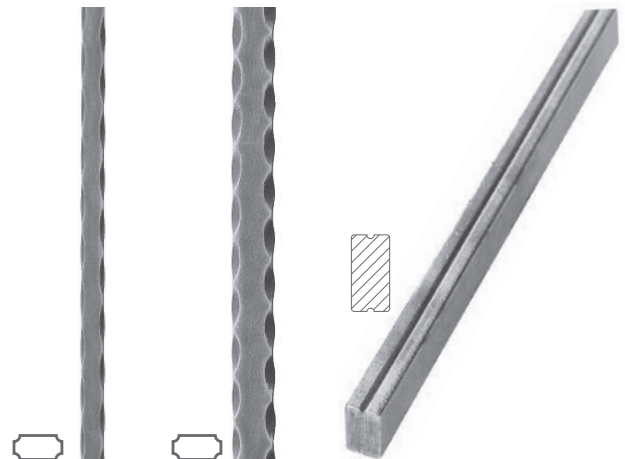

□	12x6	20x10	16x8
HxL (mm)	3000	3000	3000
N°	30.200	30.202	30.220

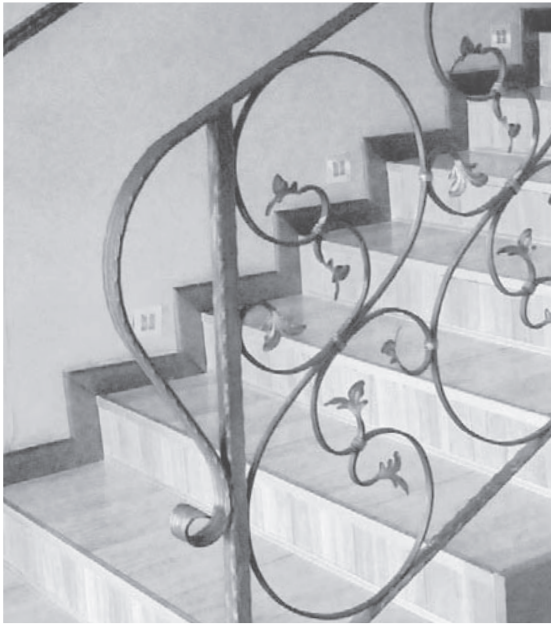

profil



□	40x5	40x5	40x5	40x5	40x5
HxL (mm)	3000	100x350	680	180x300	400
N°	30.111	30.111.01	30.111.02	30.111.03	30.111.04

profil



□	40x5	40x5	40x5	40x5	40x5
HxL (mm)	3000	100x350	680	180x300	400
N°	30.113	30.113.01	30.113.02	30.113.03	30.113.04

ORNAMENTAL STEEL

■ skavas ■ banding materials ■ ленты

soft and flexible

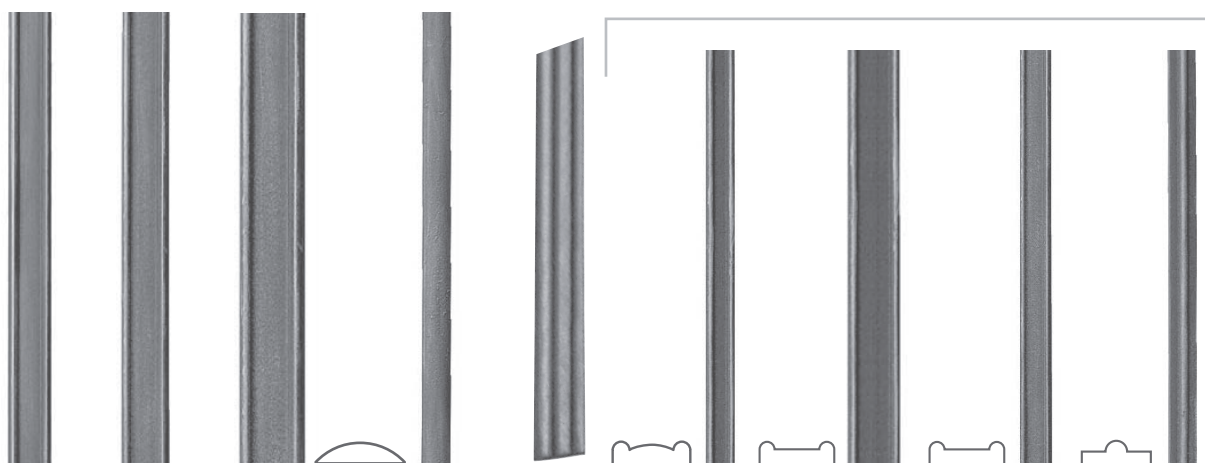

□	25x8	30x8	40x8	14x4	18x1,5	14x3	20x4	14x4	14x4
HxL (mm)	3000	3000	3000	4000	2000	3000	3000	3000	3000
N°	31.101	31.102	31.103	31.300	31.350	31.400	31.402	31.403	31.404



□	H	N°
12x12	3000	32.001
14x14	3000	32.003
16x16	3000	32.005
20x20	3000	32.007



□	H	N°
Ø8	3000	32.111
Ø10	3000	32.112
Ø12	3000	32.113
Ø14	3000	32.114
Ø16	3000	32.115
Ø20	3000	32.117
Ø24	3000	32.119



□	H	N°
Ø10-12	1100	32.100
Ø12-16	1100	32.101
Ø16-20	1100	32.102

- stieņi logu restēm ■ shaping bars and bars with openings (for gratings)
- фасонные прутья и прутья с отверстиями (для решеток)

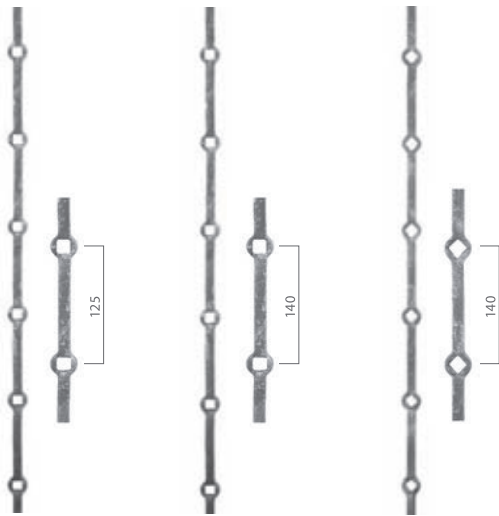

□	12x12	14x14	14x14
H (mm)	2000	2000	2000
N°	33.000	33.001	33.013

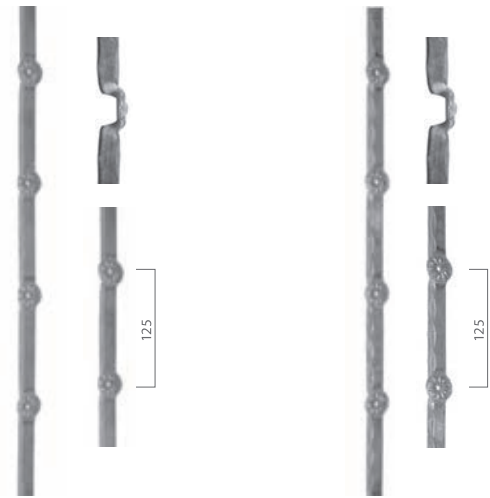

□	H	N°	□	H	N°
12x12	2000	33.098	12x12	2000	33.099
14x14	2000	33.100	14x14	2000	33.101



ORNAMENTAL STEEL

■ apspiesta profilcaurule ■ square bars textured ■ прутья

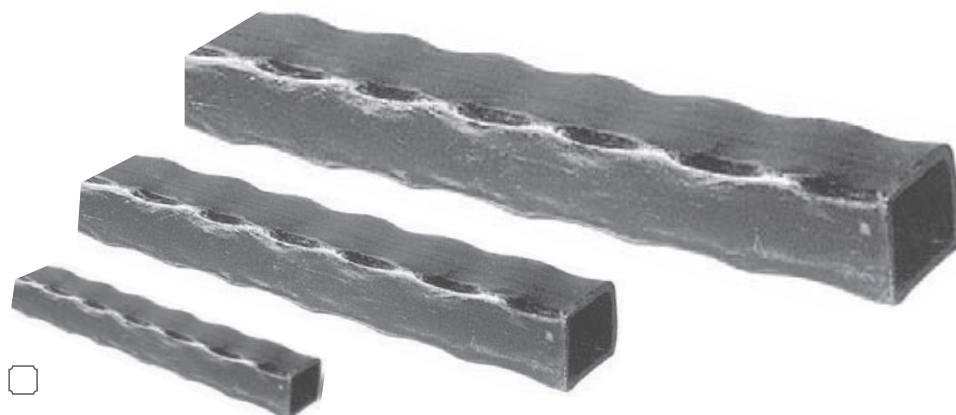
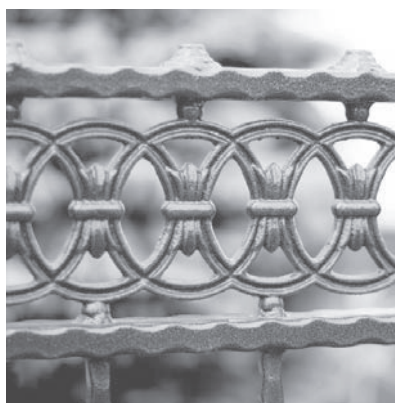

□	20x20x2	25x25x2	30x30x2	40x40x2,5
H (mm)	3000	3000	3000	3000
N°	34.002	34.005	34.008	34.011

□	50x50x3	60x60x3	80x80x3	100x100x3
H (mm)	3000	3000	3000	3000
N°	34.014	34.017	34.020	34.023

■ apspiesta profilcaurule - kvadrātveida ar tekstūru ■ rectangular bars textured
 ■ замкнутые профили - квадратные фактурные

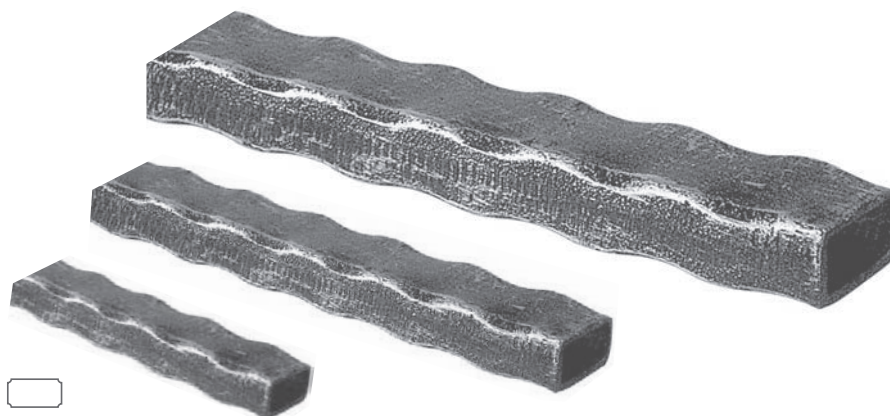

□	30x20x2	40x20x2	40x30x2	50x30x3	60x40x3
H (mm)	3000	3000	3000	3000	3000
N°	34.102	34.105	34.107	34.111	34.120



□	Ø15	Ø12	Ø15	Ø20	Ø26	Ø20	Ø30
HxL (mm)	150x55	100x45	125x55	110x70	135x70	130x70	160x90
N°	40.001	40.011	40.012	40.048	40.049	40.050	40.051

■ piķi ■ spears, points, tops ■ пики



□	Ø20	Ø25	Ø38	Ø16	Ø20	Ø26	Ø20	15x15
HxL (mm)	80x45	125x65	140x80	82x40	115x58	140x70	98x33	140x50
N°	40.055	40.056	40.057	40.060.01	40.060	40.061	40.072.01	40.078

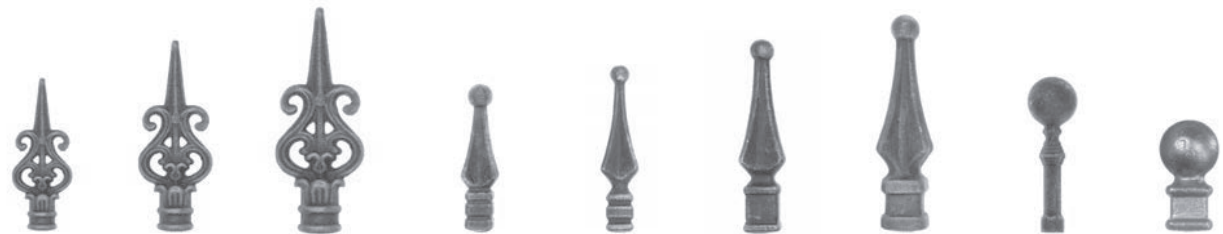

□	Ø25	Ø33	Ø40	15x15	20x20	32x32	40x40	12x12	24x24
HxL (mm)	125x45	140x57	190x68	82x20	125x30	160x40	190x50	95x27	60x35
N°	40.083	40.084	40.085	40.092.01	40.092	40.093	40.094	40.095	40.097



□	Ø24	Ø30	Ø33	18x21	25x25	30x30	40x40	Ø40	Ø16
HxL (mm)	88x28	120x35	150x40	105x53	120x67	155x92	200x117	200x100	120x73
N°	40.098.03	40.098.02	40.098.01	40.099.04	40.099.01	40.099.02	40.099.03	40.112	40.112.01



ORNAMENTAL STEEL

■ stieņu uzmašas ■ slugs, caps ■ кованные элементы, насадки



□	16x16	23x23	12,5	12,5	14,5	14,5	Ø14,5	Ø14,5
HxL (mm)	57x38	115x96	39x40	67x40	44x45	67x45	39x40	67x40
N°	40.140	40.142	41.001	41.002	41.003	41.004	41.005	41.006



□	16,5	16,5	12,5	12,5	14,5	14,5	16,5	16,5
HxL (mm)	44x45	67x45	40x38	65x38	40x38	65x38	40x38	65x38
N°	41.007	41.008	41.021	41.022	41.023	41.024	41.025	41.026



□	27	12,5	14,5	16,5	20,5	25,5
HxL (mm)	215x63	22x33	22x38	22x38	35x55	35x55
N°	41.070	41.202	41.204	41.205	41.206	41.207



□	14,5	14,5	Ø14,5	Ø14,5	16x16	16x16	Ø16	Ø16
HxL (mm)	70x35	130x35	70x35	130x35	75x42	148x48	75x38	128x40
N°	41.306	41.307	41.311	41.312	41.315	41.316	41.317	41.318

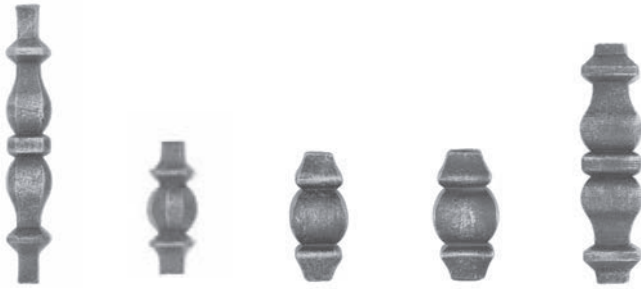

□	12x12	14x14	12-14	16-20	20x20
HxL (mm)	140x26	80x32	75x30	75x35	140x35
N°	41.401	41.403	41.407	41.408	41.409

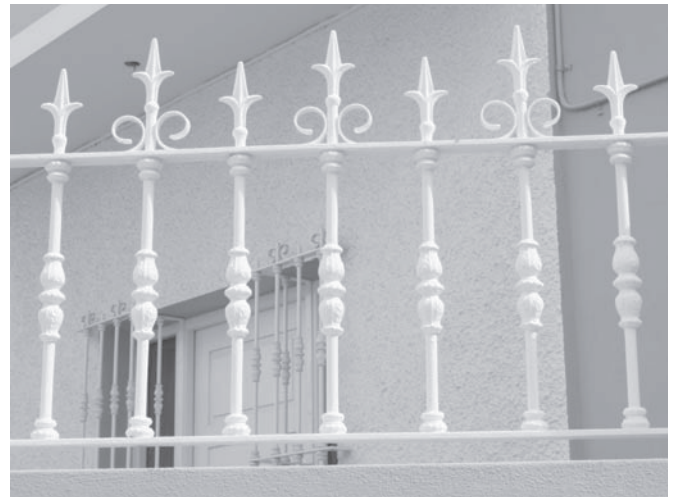

■ pīķi ■ knobs ■ набалдашники



□	Ø28	Ø40	Ø100	Ø50	25x25	40x40	Ø27	Ø42
HxL (mm)	80	90	180	90	60	85	60	85
N°	42.000	42.001	42.002	42.003	42.004	42.005	42.006	42.007



□	Ø50	Ø75
HxL (mm)	160	120
N°	42.021	42.022

ORNAMENTAL STEEL

■ pilnas bumbas ■ plain full spheres ■ шары полные гладкие



□	Ø15	Ø20	Ø25	Ø30	Ø35	Ø40	Ø50
N°	43.015	43.020	43.025	43.030	43.035	43.040	43.050

■ bumbas ar tekstūru ■ textured full spheres ■ шары сплошные фактурные



□	Ø20	Ø25	Ø30	Ø35	Ø40	Ø50
N°	43.120	43.125	43.130	43.135	43.140	43.150

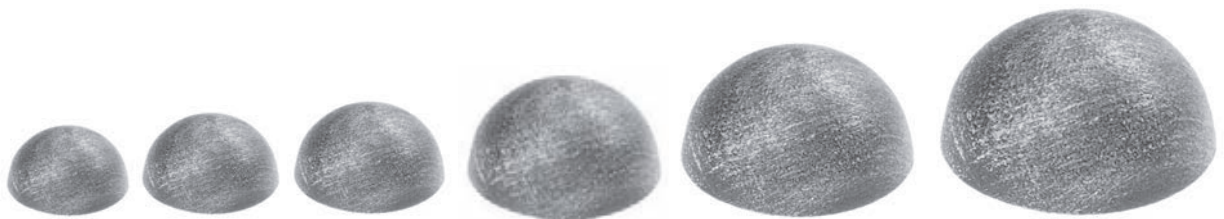

□	Ø40	Ø50	Ø60	Ø70	Ø80	Ø100	Ø120	Ø150
N°	43.504	43.505	43.506	43.507	43.508	43.510	43.512	43.515

■ tukšas bumbas ■ plain hollow spheres ■ шары полые гладкие



□	Ø15	Ø20	Ø25	Ø30	Ø35	Ø40	Ø50	Ø60	Ø70	Ø80
N°	43.615	43.620	43.625	43.630	43.635	43.640	43.650	43.660	43.670	43.680

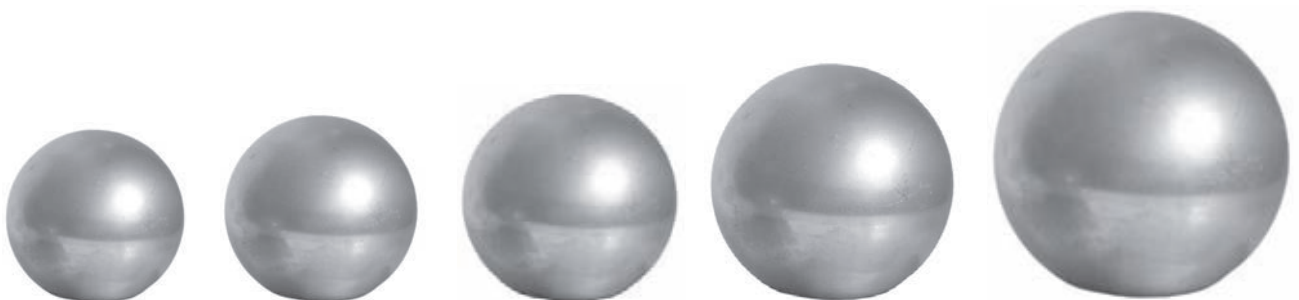

□	Ø90	Ø100	Ø120	Ø150	Ø200
N°	43.690	43.700	43.720	43.750	43.800

■ noslegplāksnes ■ masking frames, plates ■ маскировочные элементы



□					
HxL (mm)	60x60	65x65	100x100	Ø65	Ø90
	5	4	4	4	4
N°	44.014	44.017	44.020	44.026	44.029

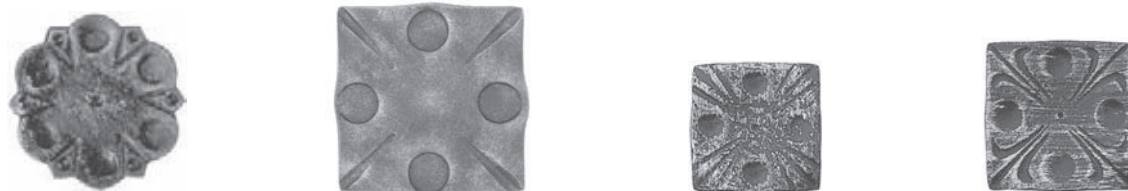

□				
HxL (mm)	Ø110	120x120	60x60	80x80
	4	8	4	4
N°	44.034	44.039	44.040	44.043

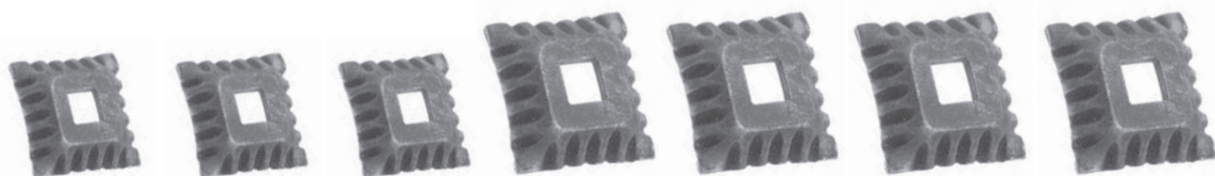

□	12,5x12,5	14,5x14,5	16,5x16,5	20,5x20,5	25,5x25,5	30,5x30,5	40,5x40,5
HxL (mm)	15x50x50	15x50x50	15x50x50	17x80x80	17x80x80	17x80x80	17x80x80
	4	4	4	4	4	4	4
N°	44.046	44.047	44.048	44.049	44.050	44.051	44.052

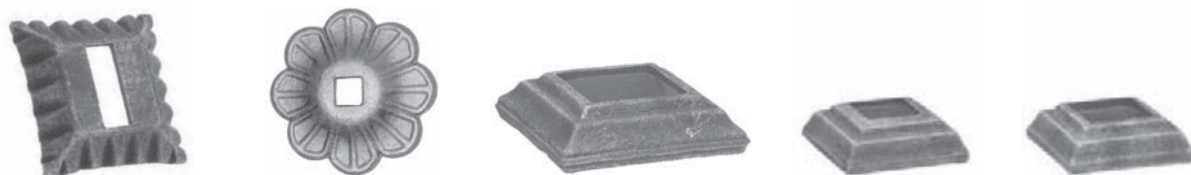

□					
HxL (mm)	40,5x20,5	14,5x14,5	40,5x40,5	25,5x25,5	30,5x30,5
	17x80x80	Ø90	25x80x80	20x60x60	20x60x60
	4	4			
N°	44.053	44.060	44.121	44.122	44.123

ORNAMENTAL STEEL

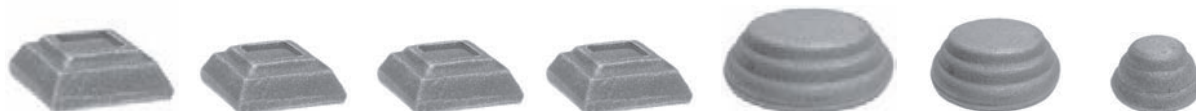

□	20,5x20,5	12,5x12,5	14,5x14,5	16,5x16,5			
HxL (mm)	20x50x50	15x40x40	15x40x40	15x40x40	Ø60x20	Ø40x20	Ø30x20
Nº	44.126	44.127	44.128	44.129	44.134	44.136	44.137



□	Ø25	Ø32	Ø38	Ø42	Ø48	Ø51
HxL (mm)	25xØ80	25xØ80	30xØ97	30xØ97	30xØ97	30xØ110
	1	1	1	1	1	1
Nº	44.140	44.141	44.142	44.143	44.144	44.145

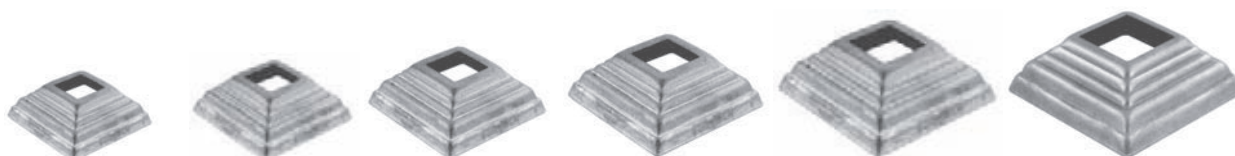

□	12x12	14x14	16x16	20x20	25x25	30x30	40x40
HxL (mm)	19x44x44	19x44x44	19x44x44	22x57x57	30x80x80	30x80x80	30x90x90
	1	1	1	1	1	1	1
Nº	44.146	44.147	44.148	44.149	44.150	44.151	44.152

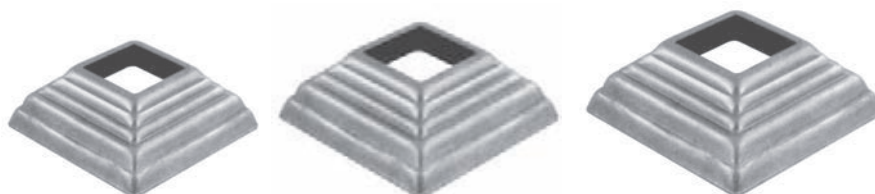

□	50x50	60x60	80x80	100x100
HxL (mm)	30x100x100	28x98x98	28x120x120	28x142x142
	1	1	1	1
Nº	44.153	44.154	44.155	44.156



HxL (mm)	155x70	120x50	145x60	200x85	280x120
	4	4	4	4	5
N°	44.200	44.201	44.202	44.203	44.204



■ puķītes, lapiņas ■ flowers, leaves, flower ornaments ■ цветы, листья, растительные орнаменты



<input type="checkbox"/>				Ø12	Ø12	Ø12
HxL (mm)	Ø95	Ø95	Ø62	Ø68	Ø97	Ø120
	5	5	4	1,5	2	2
N°	50.001	50.003	50.004	50.010	50.011	50.012



<input type="checkbox"/>	Ø10	Ø18		Ø10
HxL (mm)	Ø60	Ø95	Ø90	Ø135
	3	3	2	2
N°	50.014	50.015	50.021	50.021.01

ORNAMENTAL STEEL



<input type="checkbox"/>					
HxL (mm)	Ø65	Ø95	Ø120	Ø80	Ø60
	3	3	3	1,5	1,5
Nº	50.026	50.027	50.028	50.032	50.033



<input type="checkbox"/>					
HxL (mm)	100x70	240x140	60x45	55x30	70x50
					2
Nº	50.101	50.102	50.103	50.105	50.106
					2
					50.107



HxL (mm)	175x95	145x75	100x55	Ø25x70	Ø20x56	65x45
	2	2	2			5
Nº	50.150	50.151	50.152	50.153	50.154	50.155



HxL (mm)	150x150	115x125	85x95	70x70	160x60	120x60
	2,5	2	2	1,5		
Nº	50.156	50.157	50.158	50.159	50.165	50.166



HxL (mm)	100x80	100x50	100x50	80x80	80x80	125x80	125x80
	3	2,5	2,5	2	2	2	2
N°	51.002	51.003	51.004	51.005	51.006	51.009	51.010



HxL (mm)	100x90	100x90	80x60	80x60	120x100	120x100
	2	2	2	2	2	2
N°	51.015	51.016	51.017	51.018	51.019	51.020

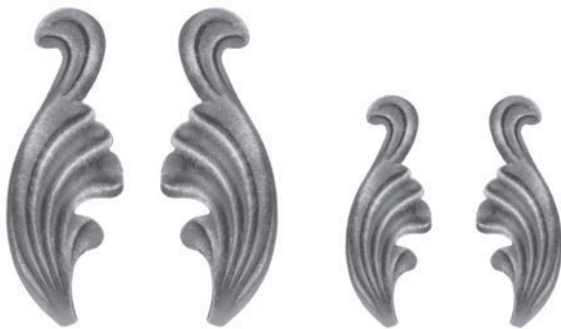

HxL (mm)	190x60	190x60	110x40	110x40
	2	2	2	2
N°	51.059	51.060	51.061	51.062



HxL (mm)	90x30	90x30	80x60	80x60
	2	2	2	2
N°	51.063	51.064	51.069	51.070



ORNAMENTAL STEEL



HxL (mm)	55x70	55x70	110x75	110x75	155x65
	2	2	2	2	2
N°	51.073	51.074	51.077	51.078	51.082



HxL (mm)	160x40	280x50	105x50	135x32	165x60
	2,5	2,5	3	3	3
N°	51.097	51.098	51.099	51.101	51.102



HxL (mm)	165x70	300x70	275x50	430x110	330x100	330x100
	4	4	4	6	5	5
N°	51.103	51.104	51.105	51.106	51.107	51.108



HxL (mm)	245x130	242x170	180x170	180x170
	2,5	2	2	2
N°	51.131	51.132	51.133	51.134



HxL (mm)	310x100	450x300
	1	1
Nº	51.410	51.412



HxL (mm)	340x260
	1
Nº	51.413



HxL (mm)	255x230	146x146	410x65	410x65
	1	1	1	1
Nº	51.411	51.420	51.426	51.425



HxL (mm)	146x146	184x184	145x145
	1	1	1
Nº	51.420	51.421	51.422

■ lietās lapiņas ■ ornamental sets – cast steel ■ декоративные системы - литая сталь



HxL (mm)	85x70	85x70	105x95	105x95	270x110	270x110
	4	4	3	3	4	4
Nº	52.001	52.002	52.003	52.004	52.005	52.006



HxL (mm)	140x65	140x65	150x130	150x130
	4	4	4	4
Nº	52.009	52.010	52.011	52.012



HxL (mm)	190x160	190x160	155x140	155x140
	4	4	4	4
Nº	52.015	52.016	52.017	52.018



HxL (mm)	250x150	250x150	220x105	220x105	180x85	180x85
	4	4	4	4	4	4
Nº	52.019	52.020	52.021	52.022	52.023	52.024



HxL (mm)	215x140	170x75	185x80	235x105	115x55
	4	4	4	4	4
Nº	52.029	52.030	52.032	52.034	52.043



HxL (mm)	135x75	160x45	240x150	240x150	190x60	175x50
	4	4	4	4	4	4
Nº	52.047	52.048	52.049	52.050	52.044	52.045

ORNAMENTAL STEEL

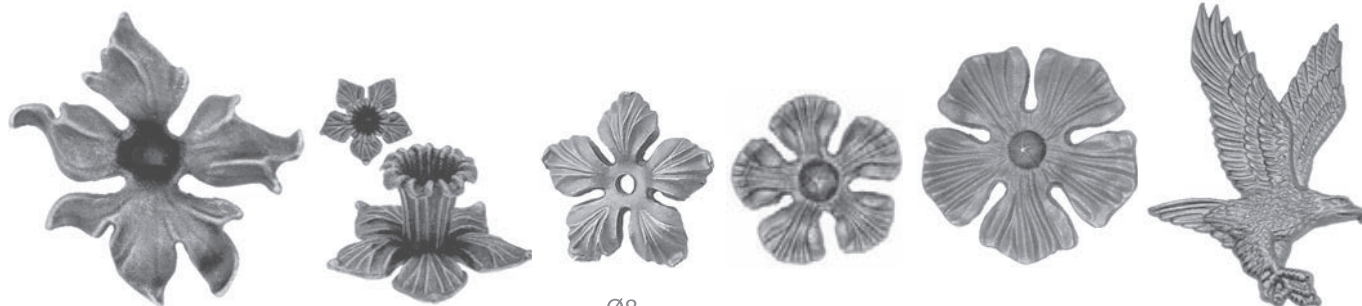

Ø8

HxL (mm)	Ø160	Ø90x60	Ø80	Ø90	Ø135	220x145
	4	4	3	5	5	12
N°	52.130	52.131	52.132	52.133	52.134	52.420

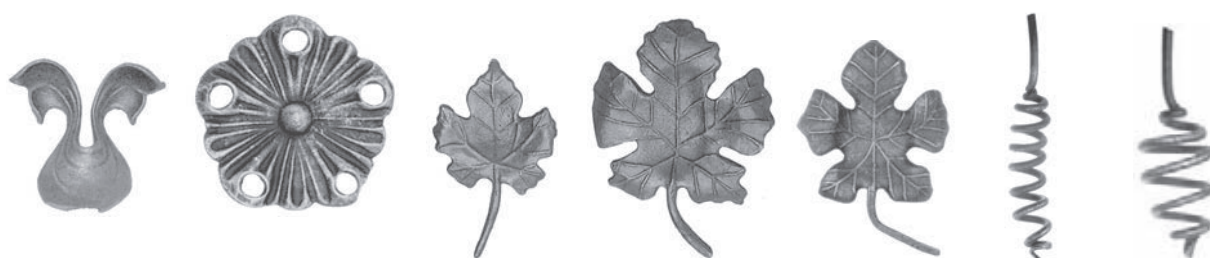

HxL (mm)	85x80	Ø100	125x75	155x110	135x85	180x28	160x43
	3	3,5	3	4	4	Ø5	Ø5
N°	52.135	52.136	52.201	52.202	52.203	52.216	52.217



HxL (mm)	Ø90	Ø55	85x70	185x90	165x125	195x100
	8	8	8	8	8	8
N°	52.300	52.301	52.306	52.404	52.405	52.406





HxL (mm)	Ø80	Ø90x70	Ø40x42
	0,5	0,6	0,6
N°	53.000	53.006	53.007



■ lējumi ■ cast iron items ■ чугунные элементы

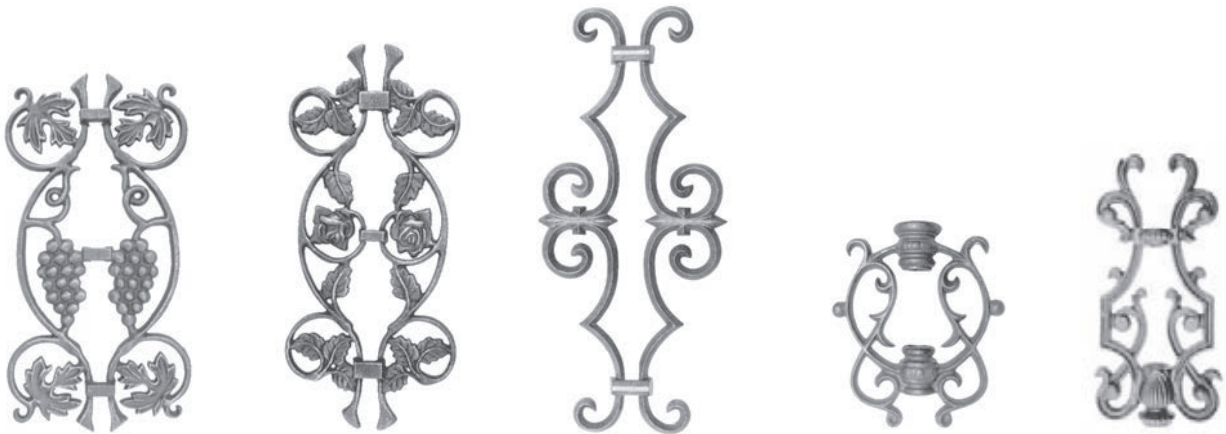

	14x14	14x14	14x14	14x14	14x14
HxL (mm)	380x190	400x190	455x200	190x150	280x130
N°	55.001	55.003	55.005	55.006	55.007

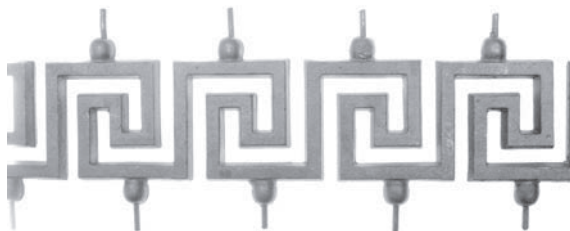

HxL (mm)	500x100
N°	55.030

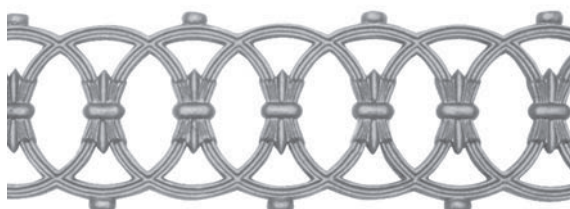

HxL (mm)	870x150
N°	55.031





		Ø100	40x40	50x50	60x60
HxL (mm)	Ø120	210x110	87	110	135
Nº	55.050	55.100	55.101	55.102	55.103



	80x80	100x100	250x160
HxL (mm)	165	180	
Nº	55.104	55.105	55.200





guide wheel

60.010



cup for rail

60.020



cup for gate 80
rubber wheels

60.024

N°	60.010	60.020				60.024



Ø25

60.040



Ø30

60.040.01



Ø32

60.040.02



Ø35

60.040.03



Ø40

60.040.05



Ø35

60.043



Ø40

60.049

N°	60.040	60.040.01	60.040.02	60.040.03	60.040.05	60.043	60.049



Ø20

61.100



Ø29

61.101



Ø20

61.102



Ø24

61.103



Ø30

61.104



Ø30

61.105

□	Ø20	Ø29	Ø20	Ø24	Ø30	Ø30
H	100	130	100	122	146	230
N°	61.100	61.101	61.102	61.103	61.104	61.105

ORNAMENTAL STEEL

■ enģes ■ hinges ■ петли



welding hinges
M16

N° **61.001**



welding hinges
M20

N° **61.002**

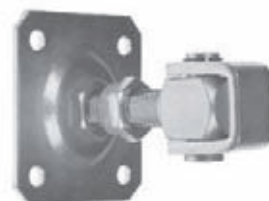

adjustable hinges
M16

N° **61.012**

adjustable hinges
M20

N° **61.013**

adjustable hinges with
shield M16, 80 x 80 x 3

N° **61.018**

adjustable hinges with
shield M20, 100 x 100 x 4

N° **61.019**

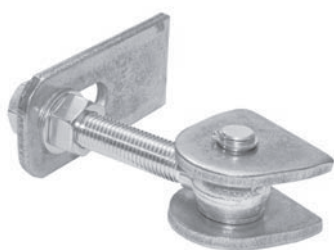

hinges M16
open angle 180°

N° **61.051**

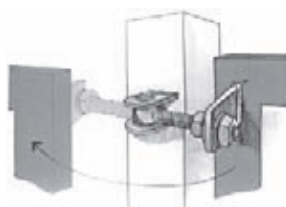

hinges M20
open angle 180°

N° **61.052**

61.051 + 61.052



gate stop
Ø 90 x 90

N° **61.090**



screw fixing gate stop
157 x 130 x 44

N° **61.091**

■ bīdāmo vārtu furnitūra



R60.010



Zn/Fe
R60.070 R60.070Fe



R60.040.03



R60.015



R60.003.70



R60.020

■ plastmasas korņi ■ stoppers ■ заглушки

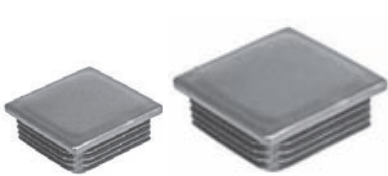

□	N°
15x15	62.200
16x16	62.201
20x20	62.202
25x25	62.203
30x30	62.204
35x35	62.206
40x40	62.207
45x45	62.208
50x50	62.209
60x60	62.210
70x70	62.211
80x80	62.212
100x100	62.213
120x120	62.214



□	N°
15x25	62.221
18x30	62.222
20x30	62.223
20x40	62.224
25x40	62.226
27x40	62.227
30x50	62.228
30x60	62.229
40x60	62.230
40x80	62.231
40x100	62.232
50x100	62.234
60x80	62.235
60x100	62.236
60x120	62.237



Ø	N°
16	62.240
18	62.241
20	62.242
25	62.243
30	62.244
32	62.245
35	62.246
40	62.247
43	62.248
50	62.249
60	62.250
70	62.251
76	62.252



□	Ø27
H	145
N°	61.106

□	Ø35
H	190
N°	61.107

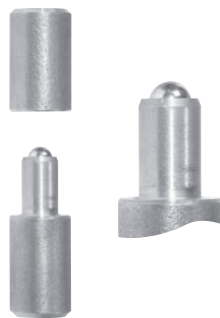

Ø	H	N°
20	70	61.120.01
24	80	61.124.01
27	90	61.127.01
30	100	61.130.01
35	120	61.135.01
40	120	61.140.01

■ jumtīņi ■ post tops ■ навесы

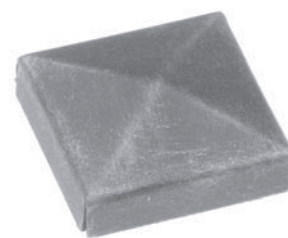

□	H	N°
20x20	1	62.002
30x30	1,5	62.003
40x40	1,5	62.004
50x50	1,5	62.005
60x60	1,5	62.006
80x80	1,5	62.008
100x100	1,5	62.010
120x120	1,5	62.012
150x150	1,5	62.015
200x200	1,5	62.020



□	Ø	Nº
40x40	40	62.004.04
50x50	50	62.005.05
60x60	60	62.006.06
70x70	60	62.007.06
80x80	60	62.008.06
100x100	80	62.010.08
120x120	100	62.012.10



Ø	Nº
42	62.031
48	62.032
60	62.033
77	62.034
90	62.035
100	62.036



Ø	Ø kula	Nº
42	60	62.042.06
48	60	62.048.06
60	60	62.060.06
72	80	62.072.08
77	60	62.077.06
80	60	62.080.06
100	80	62.100.08



□	H	Nº
60x60	90	62.106
80x80	120	62.108
100x100	140	62.110
120x120	170	62.112
150x150	200	62.115



Ø	Nº
30	62.163
40	62.164
50	62.165
60	62.166
70	62.167
90	62.169
110	62.171

■ kalti rokturi ■ forged door handles ■ кованные ручки

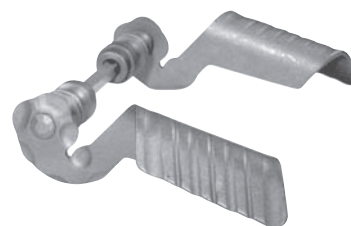

□	135x75	160x85	140x75
N°	63.001	63.005	63.006



□	135x75	110x90
N°	63.007	63.019



□	Ø60	85x65	70x65	55x65	70x116
N°	63.002	63.008	63.009	63.011	63.015

■ slēdzeņu noslegplāksnes ■ shields ■ накладки (отверстия с шогом 90 мм)



HxL (mm)	Ø65	Ø65	Ø50	Ø50	Ø50	Ø50	130x36	130x36
	2	2	2	2	4	4	4	4
N°	63.040	63.041	63.042	63.043	63.044	63.045	63.046	63.047

ORNAMENTAL STEEL

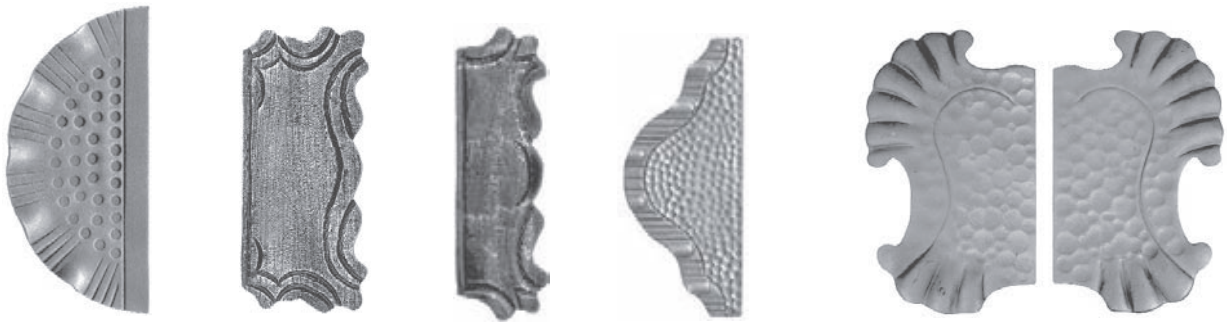

HxL (mm)	275x130	305x135	295x90	295x120	275x160	275x160
	3	4	4	3	3	3
Nº	63.101	63.108	63.111	63.114	63.117	63.118



HxL (mm)	270x165	270x165	280x110
	2	2	2
Nº	63.125	63.126	63.129



HxL (mm)	315x135	330x175	330x175
	3	3	3
Nº	63.146	63.151	63.152



locking mechanism with hook and faceplate

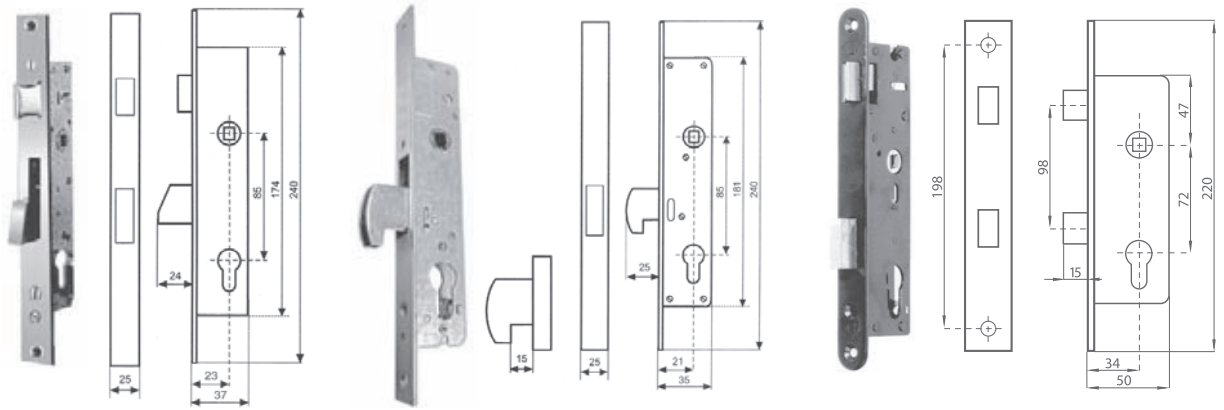

85/20

85/20

72/35

N° **63.208**

N° **63.209**

N° **63.211**



□	245 / 50x30	245 / 60x40
	72/35	72/35
N°	63.220	63.222



■ balsti ■ fixings ■ крепления



HxL (mm)	180x95
	12x12
N°	64.012

■ kniedes ■ rivets ■ заклепки



HxL (mm)	36xØ19	36xØ18
	Ø6	Ø6
Nº	64.020	64.022

■ Aizbīdņi un atslēgas ■ bolts and locks ■ щеколды и засовы

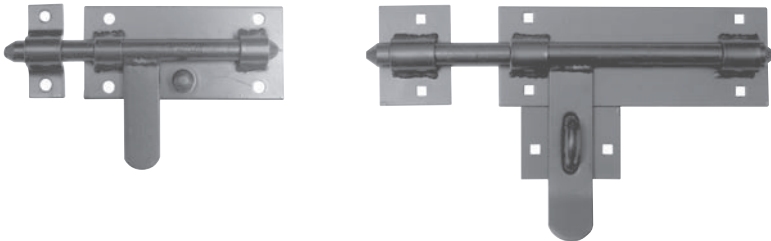

L (mm)	150	270
	Ø12	Ø16
Nº	64.050	64.051

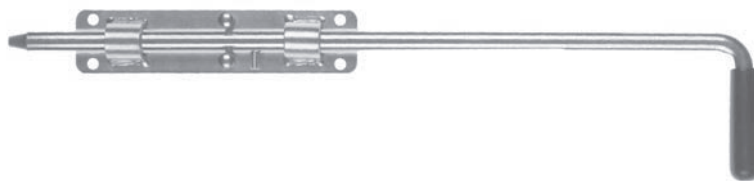

L (mm)	420
	Ø14 galvanized
Nº	64.064

■ vēja rādītāji ■ weathervanes ■ флюгера

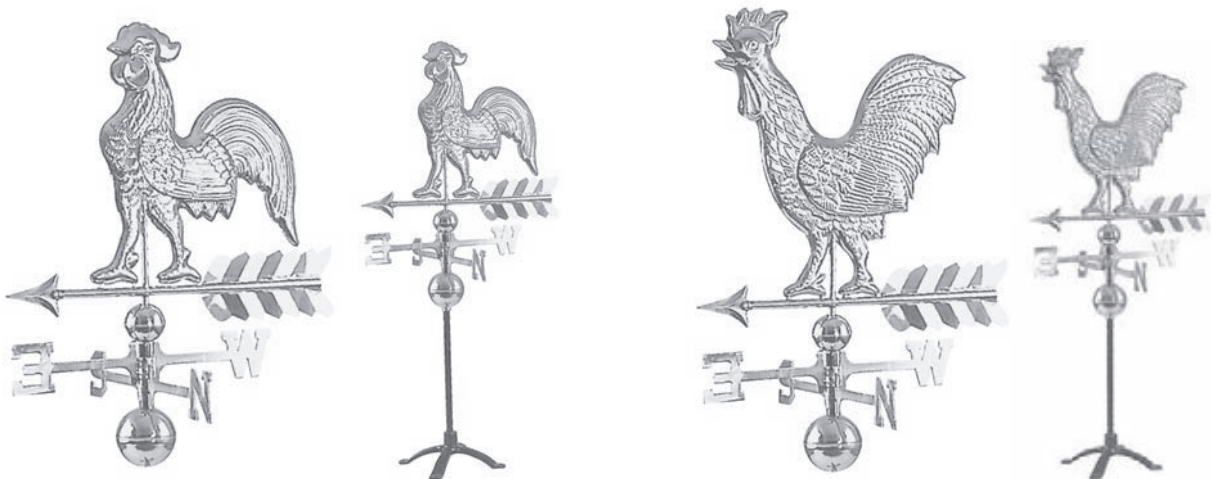

H (mm)	1400	1200
N°	65.001	65.002

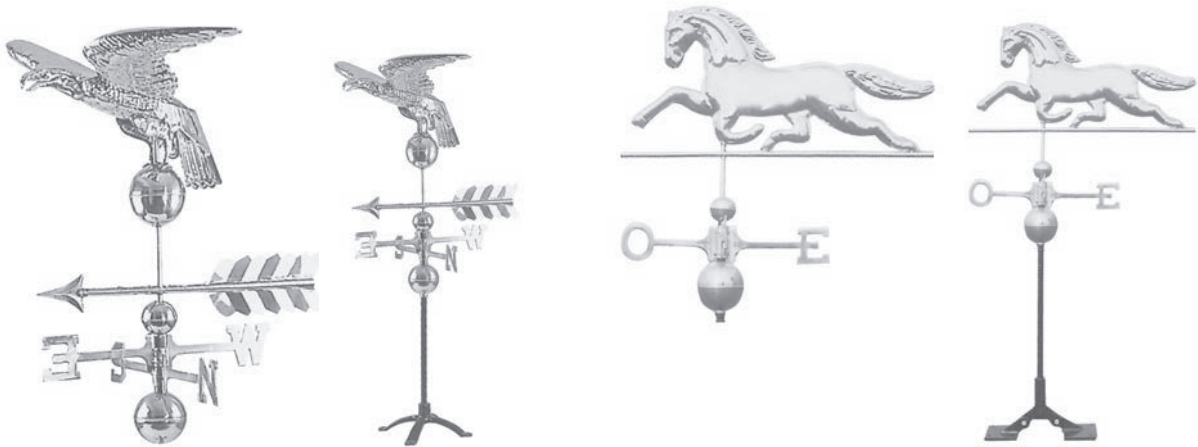

H (mm)	1400	1000
N°	65.003	65.004

■ pastkastītes ■ mail boxes ■ почтовые ящики



HxL (mm)	405x255	405x255	405x255
	90	90	90
N°	65.200	65.201	65.202



HxL (mm)	445x395	445x395
	170	170
Nº	65.210	65.211



HxL (mm)	370x360	370x360
	132	132
Nº	65.250	65.250.01
		65.251



HxL (mm)	370x360	300x210	300x210
	132	65	65
Nº	65.255	65.260	65.261



SIA "LATVIJAS NEATKARĪGAIS SPECIĀLISTU
ATESTĀCIJAS UN SERTIFIKĀCIJAS CENTRS"
LATVIA INDEPENDENT SPECIALISTS CERTIFICATION CENTER Ltd.

www.insasc.lv

Meža iela 7
Rīga, LV-1048

Fakss: +371 67408215

Tālr: +371 67610032

+371 29714961

+371 29391179

e-pasts: insasc@insasc.lv

insasc@inbox.lv

SIA «Latvijas neatkarīgais speciālistu atestācijas un sertifikācijas centrs» (LNSASC) sadarbībā ar Latvijas neatkarīgo testēšanas laboratoriju, Latvijas neatkarīgo inspekciju un vadošajiem metināšanas iekārtu un piederumu izplatītājiem, sākot ar 1.oktobri uzsāk akciju Latvijas metālapstrādes uzņēmumu un būvuzņēmumu atbalstam.



Akcijas laikā visiem interesentiem būs iespēja nokārtot starptautiski atzītu metinātāja sertifikātu saskaņā ar LVS EN 287 sērijas standartiem par **LVL 5.00+PVN** Sertifikātu varēs iegūt gan reglamentētajā, gan nereglamentētajā sfērā.

Akcijas mērķis:

- Sniegt metālapstrādes un būvniecības uzņēmumiem atbalstu sarežģītajā ekonomiskajā situācijā.
- Izskaust situāciju, kad uzņēmumos tiek nodarbināti kvalificēti, bet nesertificēti darbinieki, kas nevar dokumentāli pierādīt savu profesionalitāti.
- Ar sertifikācijas procesa un konsultāciju palīdzību veidot uzņēmumos lielāku izpratni par metinātāju un metināšanas procesu sertifikāciju un ar to saistītajām priekšrocībām.
- Sniegt iespēju katram kvalificētam metinātājam sertificēties, kas pavērs plašākas darba iespējas.

akcija



Plazma Plus



KEMPPI
The Joy of Welding

TEKNOS PIEDĀVĀ PLAŠU KRĀSU UN PĀRKLĀJUMU SORTIMENTU RŪPnieciskai izmantošanai, tostarp pulverkrāsu pārklājumus un antikorozijs krāsas metālam, kokapstrādes krāsas, kā arī krāsas minerālu un plastmasas virsmām.

TEKNOS SIŪLO PLATŪ PRAMONINIŪ DAŽŪ IR DANGŪ ASORTIMENTĀ, KURĪ SUDARO MILTELINĒS DANGOS, DAŽAI METALINIAMS, MEDINIAMS, MINERALINIAMS IR PLASTIKINIAMS PAVIRŠIAMS.

TEKNOS ПРЕДЛАГАЕТ ШИРОКИЙ ДИАПАЗОН ПРОМЫШЛЕННЫХ КРАСОК И ПОКРЫТИЙ, В ТОМ ЧИСЛЕ, ПОРОШКОВЫЕ ПОКРЫТИЯ И АНТИКОРРОЗИОННЫЕ КРАСКИ ДЛЯ МЕТАЛЛИЧЕСКИХ, ДЕРЕВЯННЫХ, КАМЕННЫХ И ПЛАСТИКОВЫХ ПОВЕРХНОСТЕЙ.

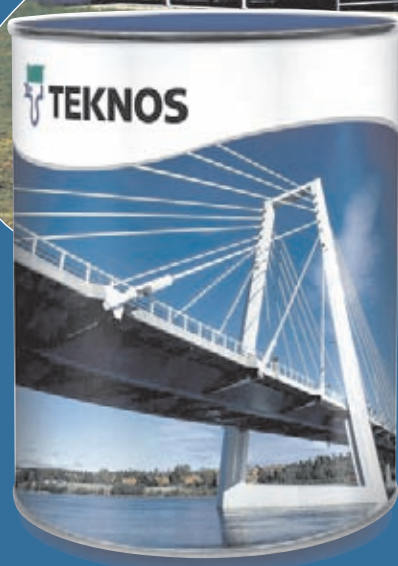



METĀLKALUMI **ORNAMENTAL STEEL**

www.deksteel.lv

Par mums - Ornamental Steel SIA

Sia "Ornamental Steel" savu darbību sākusi 2008. gadā. Jauns, perspektīvs uzņēmums. Pamata nodarbošanās ir dekoratīvo metālkalumu tirdzniecība. Mūsu mērķis ir maksimāli ātri nodrošināt klientu pieprasījumu pēc mūsu produkcijas. Dekoratīvie elementi no metāla: tās ir unikālas sagataves jebkura veida metālizstrādājumiem, kas spēj padarīt skaistāku gan mājas interjeru, gan arī tās eksterjeru. Dekoratīvie kalumi ir izgatavoti uz mūsdienu augstākās tehnoloģijas iekārtām, kas nodrošina kvalitāti un precizitāti saviem izmēriem. Ar minimālām izmaksām, nepatērējot daudz laika, Jūs varat izgatavot skaistu metālizstrādājumu. Piedāvājam vairāk kā 1500 veidu dekoratīvo elementu. Dekoratīvie metāla kalumi - sētām, margām, mēbelēm, interjeram un... Jūsu idejām.

About Us - Ornamental Steel SIA

Sia "Ornamental Steel" started its activities in the 2008th year. New, promising company. The basic activity is the sale of ornamental metal forgings. Our objective is to quickly deliver on customer demand for our products. Our company engaged in the productions of the finished product, so that our clients are not competitors. Decorative elements of metal: they are unique to preforms any type of metal parts that can make beautiful homes and interiors, as well as its exterior. Decorative Hardware is made of modern high-tech equipment to ensure quality and accuracy of its dimensions. With minimal cost, during your time, you can make a beautiful metal. We offer more than 1,500 types of decorative elements. Ornamental metal forgings - fences, railings, furniture, interior and... your ideas.

О компании Орнаментал Стел ООО

Мы являемся фирмой, действующей в стальной отрасли с 2008 года. Будучи производителем и прямым импортером стальных кованых элементов, аксессуаров для ворот и ограждений, мы являемся самой динамично развивающейся фирмой в Латвии. Снабжаем подрядчиков и торговые фирмы на территории всей страны, а также за ее пределами. Своими успехами на рынке мы обязаны профессиональному обслуживанию, величине и привлекательности предложения. В настоящий момент в постоянной продаже находится более 2000 изделий. Стараемся также заботиться как о качестве поставляемых нами продуктов, так и об их ценовой конкурентоспособности.

Sia "Ornamental Steel"

Mob. +371 20360910 LV

Mob. +371 20369065 Export

Mail: metalpartner@inbox.lv